

# **BEKO**

## **COLOUR TELEVISIONS**

**Service  
Manual  
14.2**

# SERVICE BULLETIN

TV

**BEKO**

TV

No. OF ISSUE : SB-BK0202

ISSUE DATE : 2002. 09. 06

BUYER NAME : LG	BUYER(LGE) MODEL : 28CZ10RX, 32CZ10RX
BEKO MODEL : V30, T82	DATE OF CHANGE : 2002.08.24
APPLICABLE SERIAL NO. : Immediately	
SUBJECT : Damage of FBT due to Arcing (Replacing Termal brand FBT with Eldor FBT)	

? Application Model :

## 1. GENERAL INFORMATION

NO	LOCA NO.	BEFORE CHANGE		AFTER CHANGE		I / C	N/C
		PART NO.	DESC. / SPEC.	PART NO.	DESC. / SPEC.		
1	TR502	058834-TR5	28" 16:9 FBT (Termal)	057834-EL2	28" 16:9 FBT (Eldor)	C	3
1	TR502	058234-TR5	32" 16:9 FBT (Termal)	057234-EL3	32" 16:9 FBT (Eldor)	C	3
	<b>R529</b>	<b>119110</b>	<b>RMF 1R J 1W</b>	<b>119155</b>	<b>RMF 1.5R J 1W</b>	<b>C</b>	<b>3</b>

## 2. SYMPTOM/REASON :

The FBT is damaged due to arcing as shown in the attached picture. If the FBT is produced by Termal, it must be changed with an Eldor FBT.

Note: The pin positions (on PCB) of Termal and Eldor brand FBT's are different. Thus, 3 metal eyelets should be removed and 5 eyelets should be added.

Please apply the following procedure to replace Termal FBT with Eldor FBT:

- Desolder the pins of Termal FBT and remove it.
- Remove the metal eyelets in position E17, E19 and E20 by cutting heads on the component side of PCB (It is not necessary to remove E18)

Not: It is needed to prevent a possible arcing from ferrite of Eldor FBT to the eyelets of old FBT.

- Place metal eyelets (part code : 013114 ) to positions E12, E13, E14, E15 and E16.
- Fasten eyelets by applying pressure to the solder side with a (+) type screwdriver and turn it.
- Solder new Eldor FBT on the positions E12, E13, ... (see the component-side layout below).

➡ If CPT brand is 28" Video Color (W66EJU023X015), then Heater resistor R529 has to be replaced from 1R to 1.5R to decrease the Heater voltage (for other CPT brands and screen sizes, the R529 should not be replaced).

?? The part number of FBT is actually 058838(28") and 058238(32") in SPPL. So, if you order with those part number, Beko will deliver Eldor FBT automatically.

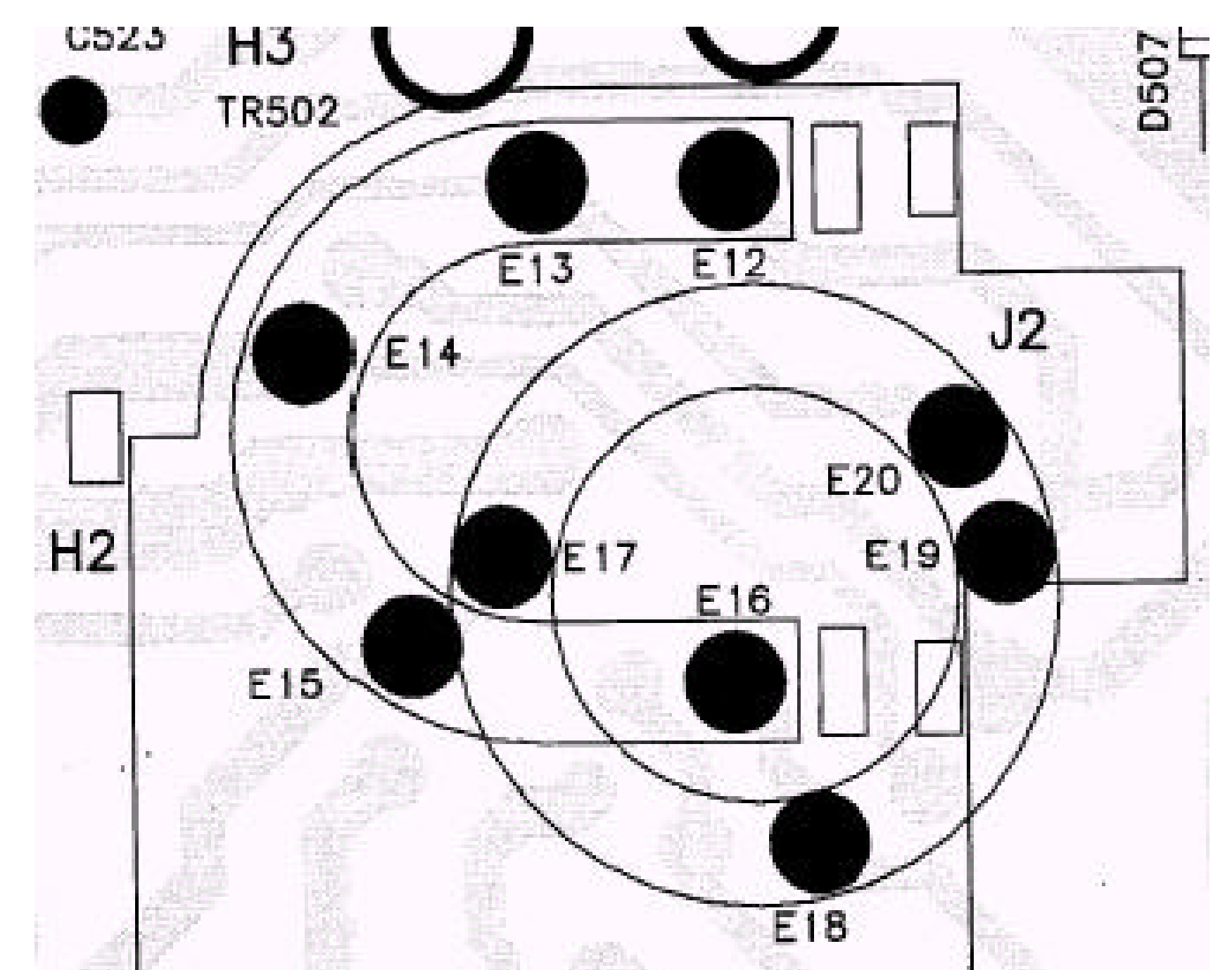

➡ FILE THIS SERVICE BULLETIN WITH YOUR SERVICE MANUAL ➡

I/C : INTERCHANGEABILITY CODE		N/C : NUMERAL CODE	
code A	<b>Interchangeable</b> : Old and new parts can be used in products as the bulletin regardless of manufacture date.	1.	To improve performance
B	<b>Old parts can be substituted for new parts</b> : Old parts can be used in previous products only. But new parts can be used regardless of manufacture date.	2.	To improve productivity
C	<b>New parts can be substituted for old parts</b> : Only new parts can be used in products regardless of manufacture date.	3.	To improve reliability
D	<b>Not interchangeable</b> : New parts can be used in new products only.	4.	Change of material or dimension
		5.	Addition
		6.	Deletion
		7.	Correction

Cengiz ARAT

CHIEF ENGINEER, R&D

Sükrü AKTAS

MANAGER, QA

<b>CONTENTS</b>	<b>PAGE</b>
Safety Instructions	3
Technical Specifications	4
Pin Voltages of IC's	5
Pin Voltages of Some Transistors	8
Oscillograms	9
Electrical and Service Adjustments	12
Trouble Shooting Guide	16
Parts List	23
Circuit Diagram PIP Module	30
Circuit Diagrams	Attached

## SAFETY INSTRUCTIONS

### GENERAL GUIDELINES

1. It is advised to insert an isolation transformer in the AC supply before servicing a hot chassis.
2. Potentials as high as 33KV are present when this receiver is in operation. Operation of the receiver without the rear cover involves the danger of a shock hazard from the receiver power supply. Servicing should not be attempted by any one who is not competent with the precautions necessary when working on the high voltage equipment. Always discharge the anode of the tube.
3. When servicing observe the original lead dress in the high voltage circuits. If a short circuit is found, replace all the parts which have been overheated or damaged by the short circuit.
4. Always use the manufacturer's replacement safety components. The critical safety components marked with  $\Delta$  on the schematics diagrams should not be replaced by other substitutes. Other substitute may create the electrical shock, fire or other hazards. Take attention to replace the spacers with the originals. Furthermore where a short circuit has occurred, replace those components that indicate evidence of overheating.
5. After servicing, see that all the protective devices such as insulation barriers, insulation papers, shields and isolation R-C combinations are correctly installed.
6. When the receiver is not being used for a long time of period of time, unplug the power cord from the AC outlet.
7. After servicing make the following leakage current checks to prevent the customer from being exposed to shock hazard.

### LEAKAGE CURRENT COLD CHECK

1. Unplug the AC cord and connect a jumper between the two prongs of the plug.
2. Turn the receiver's power switch on.
3. Measure the resistance value with an ohmmeter, between the jumpered AC plug and each exposed metallic cabinet part on the receiver, such as screw heads, aerials,

connectors, control shafts etc. When the exposed metallic part a return path to the chassis the reading should be between 4Mohm and the 20Mohm. When the exposed metal does not have a return path to the chassis, the reading must be infinite.

### LEAKAGE CURRENT HOT CHECK

1. Plug the AC cord directly in to the AC outlet. Do not use an isolation transformer for this check.
2. Connect a 2Kohm 10W resistor in series with an exposed metallic part on the receiver and an earth, such as a water pipe.
3. Use an AC voltmeter with high impedance to measure the potential across the resistor.
4. Check each exposed metallic part and check the voltage at the each point.
5. Reverse the AC plug at the outlet and repeat each of the above measurements.
6. The potential at the any point should not exceed 1.4 Vrms. In case a measurement is outside the limits specified, there is the possibility of a shock hazard, and the receiver should be repaired and rechecked before it is returned to the customer.

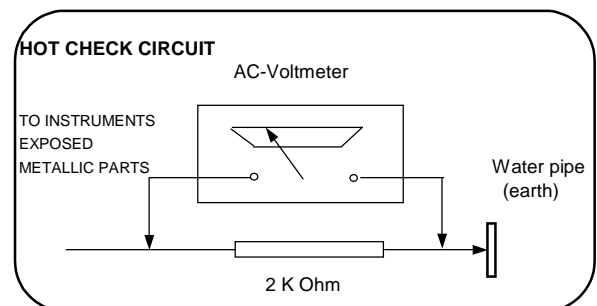

Figure 1

### X-RAY RADIATION WARNING

The primary source of X-ray radiation in this receiver is the picture tube. The chassis is specially constructed to limit X-ray radiation. For continued X-ray radiation protection, replace the tube with the same type of the original one.

### CAUTION

**AFTER REMOVAL OF THE ANODE CAP, DISCHARGE THE ANODE OF THE PICTURE TUBE AND THE ANODE CAP TO THE METAL CHASSIS, CRT SHIELD, OR THE CARBON PAINTED ON THE CRT WITH A HIGH VOLTAGE PROBE AND MULTIMETER (SELECT VDC) AND THEN SHORT CIRCUIT DIRECTLY TO DISCHARGE COMPLETELY.**

## TECHNICAL SPECIFICATIONS

<b>Power source:</b>	220-240 VAC, 50-60Hz	
<b>Power consumption (max.) <sup>1</sup>:</b>	120 W	21" Pure Flat
	125 W	25", 28" Mono
	145 W	25", 28" 4/3, 29" Pure Flat
	140 W	29" Super Flat
	150 W	28" 16/9 Super Flat
	155 W	28" 16/9 Pure Flat, 32" Super Flat
	165 W	32" Pure Flat
	160 W	33"
<b>Standby power consumption :</b>	3 W	
<b>Aerial impedance :</b>	75Ohm, coaxial type	
<b>Receiving system <sup>2</sup>:</b>	PAL BG PAL SECAM BG PAL SECAM BG DK PAL SECAM BG LL' PAL I	
<b>Receiving channels:</b>	VHF BAND I ,	CH2-4
	VHF BAND III ,	CH5-12
	CABLE TV	S1-41
	UHF BAND	CH21-69
<b>NTSC Playback Frequencies:</b>	3.58&4.43 MHz	
<b>Audio outputs :</b>	Stereo : 2 x 10W RMS at %10 THD (Except 21" Pure Flat) 2 x 7W RMS at %10 THD (21" Pure Flat) + 20W RMS at %10 THD (if subwoofer available)	
	Mono : 2 x 7W RMS at %10 THD	
<b>High Voltage :</b>	28.5 ± 0.5 KV	25", 28" 4/3
	29.0 ± 0.5 KV	28" 16/9, 29", 32" Super Flat
	29.5 ± 0.5 KV	32" Pure Flat, 33"
<b>Focus voltage :</b>	%25.6 ± %38 of EHT	
<b>Grid 2 voltage :</b>	0-1400 V	
<b>Heater voltage :</b>	6.2 ± 0.2 Vrms	
<b>Video/Audio Terminals :</b>	AV1/2 IN	Video : 1 Vpp, 75 Ohm Audio : 0.5 Vrms, >10 Kohm
	AV1 IN	RGB
	AV1/2 OUT	Video : 1 Vpp, 75 Ohm Audio : 0.5 Vrms, <1 Kohm
	AV2 IN (RCA)	Video : 1 Vpp, 75 Ohm Audio : 0.5 Vrms, >10 Kohm
<b>Operating temperature :</b>	0-45 Degrees	
<b>Safety :</b>	IEC 65 /BS P2N	
<b>X-Ray radiation :</b>	ACC. IEC 65/BS P2N	

<sup>1</sup> : 20W should be added to find the max. power consumption of the models with subwoofer.

<sup>2</sup> : TV set is produced to receive "one" of these colour and sound systems.

## PIN VOLTAGES OF IC'S

<b>IC101 (TDA956X H)</b>					
<b>TV signal processor-Teletext Decoder with embedded Micro Controller</b>					
<b>Pin</b>	<b>Connection</b>	<b>V DC (*)</b>	<b>Pin</b>	<b>Connection</b>	<b>V DC (*)</b>
1	Volume +/-	3,2 (3,2)	41	Gnd for TV processor	0 (0)
2	Status 1	0 (0)	42	External CVBS input	0 (0)
3	Status 2	0 (0)	43	Gnd for TV processor	0 (0)
4	Digital ground for u-controller	0 (0)	44	SVHS-Y input	3.3 (0)
5	Not connected	0.75 (0.25)	45	SVHS-C input	0 (0)
6	Standby on/off	0.01 (3.9)	46	White stretch capacitor	3.4 (0)
7	Analog Gnd of text decoder and dig Gnd of TV processor	0 (0)	47	CVBS output	2.8 (0.07)
8	Secam PLL decoupling	2.3 (0)	48	Audio output/AM audio output	3.45 (0)
9	2nd supply voltage TV proc (8V)	8.0 (0.26)	49	2nd IF video output (not conn.)	
10	Supply volt.deccoup. of dig. Gnd of TV processor	5.0 (0)	50	2nd RGB / YUV insertion input	0.17 (0)
11	Phase 2 filter	2.73 (0)	51	Red input	2.6 (0)
12	Phase 1 filter	3.9 (0)	52	Green input	2.6 (0)
13	Gnd 3 for TV processor	0 (0)	53	Blue input	2.6 (0)
14	Decoupling bandgap	4.0 (0)	54	Beam current limiter input	2.6-3.4 (0)
15	AVL (90 versions) / East/West drive signal (110 versions)	3.0 (0.5)	55	Black current input / V-guard input	4.6-5.7 (0)
16	V-drive B output	1.0 (0)	56	Red output	see oscilog.
17	V-drive A output	1.0 (0)	57	Green output	see oscilog.
18	IF-1 input	1.8 (0)	58	Blue output	see oscilog.
19	IF-2 input	1.8 (0)	59	Analog supply of text decoder and dig.supply of TV proc (3.3V)	3.3 (3.3)
20	Reference current input	3.9 (0)	60	OTP programming voltage	0 (0)
21	Vertical sawtooth capacitor	3.8 (0)	61	Dig. Supply to core (3.3V)	3.3 (3.3)
22	Tuner AGC output	4.3 (0)	62	X-tal Gnd	0 (0)
23	Sound IF input 1	1.9 (0)	63	X-tal input	
24	Gnd	0 (0)	64	X-tal output	
25	Gnd	0 (0)	65	Programming Reset (not connected)	0 (0)
26	Narrow band PLL filter	2.2 (0)	66	Dig. Supply to periphery (3.3V)	3.3 (3.3)
27	AVL (Automatic Vol. Levelling)	0.4 (0.08)	67	SCL1 (Eeprom)	3.3 (3.3)
28	Ext. Audio (audio 2) input	3.7 (0.08)	68	SDA1 (Eeprom)	3.3 (3.3)
29	Audio 3 input (not connected)	3.7 (0.09)	69	IR input	3.3 (3.3)
30	H-drive output	2.3 (0.26)	70	Not connected	
31	Sandcastle output-Hor.Fly.input	0.6 (0.25)	71	SCL	see oscilog.
32	Decoupling sound demodulator	2.0 (0)	72	SDA	see oscilog.
33	QSS intercarrier output / AM output	3.4 (0.3)	73	MSP reset (IC301)	4.9 (0)
34	EHT / overvoltage protection input	2.2 (0.08)	74	Mute	0 (3.3)
35	IF-PLL loop filter	2.4 (0)	75	SVHS switching	3.3 (3.3)
36	Sound IF AGC	0.5 (0)	76	L/L' switching	3.3 (3.3)
37	QSS output	0.6 (0)	77	F Blank MM Not conn.	3.3 (3.3)
38	IF video / selected CVBS output	3.0 (0)	78	Program +	3.3 (3.3)
39	main supply voltage TV processor	8.0 (0.25)	79	CVBS sync filter	3.3 (1.8)
40	Internal CVBS input	3.8 (0)	80	Program -	3.3 (3.3)

(\*) Standby values are given in parenthesis

Note: The function of pin 15, 27, 33 and 48 is dependent on the mode of operation (mono intercarrier mode / QSS IF amplifier and East-West output or not) and is controlled by some software control bits.

**IC 301 (MSP 3400G) MULTI STANDARD SOUND PROCESSOR**

Pin	Connection	V DC	Pin	Connection	V DC
1	Not connected		33	Scart 2 sound output (R)	3.7
2	Gnd	0	34	Scart 2 sound output (L)	3.7
3	Gnd	0	35	Reference analog ground	0
4	Digital control input/output	0	36	Scart 1 sound output (R)	3.7
5	Digital control input/output	0	37	Scart 1 sound output (L)	3.7
6	Gnd	0	38	Volume capacitor Headphone	
7	Standby (in normal operation it must be high)	4.9	39	Analog Supply High Voltage (8V)	8
8	Not connected	4.9	40	Volume capacitor Speaker	
9	SCL	2.4-2.6	41	Ground for Analog Power Supply High	0
10	SDA	1.8-2.1	42	Internal Analog Reference Voltage	3.7
11	Not connected	2.4	43	Scart 4 input (L)	3.7
12	Not connected	2.4	44	Scart 4 input (R)	3.7
13	Not connected	2.4	45	Analog Shield Ground	0
14	Not connected	4.9	46	CINCH - sound input (L)	3.7
15	Not connected	0.7	47	CINCH - sound input (R)	3.7
16	Not connected	0.7	48	Analog Shield Ground	0
17	ADR Bus Clock Output	0.7	49	Scart 2 sound input (L)	3.7
18	Digital Circuitry Supply Voltage	4.9	50	Scart 2 sound input (R)	3.7
19	Digital Circuitry Supply Ground	0	51	Analog Shield Ground	0
20	Not connected	0.7	52	Scart sound 1 input (R)	3.7
21	Not connected (Ground)	0	53	Scart 1 sound input (L)	3.7
22	Not connected (Ground)	0	54	A/D converter ref. Voltage	2.5
23	Not connected (Ground)	0	55	Mono sound input	3.7
24	MSP RESET input	4.9	56	Ground for Analog Power Supply Voltage	0
25	Headphone sound output (R)	2.1	57	Analog Power Supply Voltage (5V)	4.9
26	Headphone sound output (L)	2.1	58	IF input 1	1.5
27	Reference analog ground	0	59	IF Common reference for IF IN1/IN2	1.5
28	Speaker output (R)	0.1-2.1	60	IF input 2	0
29	Speaker output (L)	0.1-2.1	61	Factory test mode enable (ground)	0
30	Not connected	0.1-2.1	62	Crystal oss. input	2.3
31	Not connected	0.1-2.1	63	Crystal oss. output	2.3
32	Not connected	0	64	Not connected (Ground)	0

**IC303, IC304 (TDA7263) Audio Output IC**

Pin	Connection	V DC	Pin	Connection	V DC
1	Left In	1.6	7		0,5-0,9
2	Left In V	1.6	8	Right out	14.2
3	Mute	15.3	9	VS	28
4	Right In V	1.6	10	Left out	13.9
5	Right In	1.6	11		0,5-0,9
6	Gnd	0	12	Left In	0.6

**IC501 (TDA835X) Vertical Deflection Output IC**

Pin	Connection	V DC	Pin	Connection	V DC
1	Input A	0,98 (0)	6	Vertical Flyback Supply Voltage	45,6 (10,9)
2	Input B	0.94 (0)	7	Output A	7,64 (0,1)
3	Supply voltage	14,7 (1.0)	8	Guard Output	0,3 (0)
4	Output B	7,55 (0,4)	9	Feedback Input	7,9 (0)
5	Gnd	0 (0)			

**IC601 (MC44608 AP) Power Supply IC**

Pin	Connection	V DC	Pin	Connection	V DC
1	Demag	0.85 (0.0)	5	Driver	2.1 (0.14)
2	I sense	0.1 (0.32)	6	VCC	12.3 (8.8)
3	Control input	5 (5.5)	7	Not connected	-
4	Gnd	0	8	VI	116 (117)

(\*) Standby values are given in parenthesis

### IC701 (TDA6107) RGB Output IC

Pin	Connection	V DC	Pin	Connection	V DC
1	Red in	2.3-2.5	6	Vdd supply	190
2	Green in	2.5-2.7	7	Red out	134-137
3	Blue in	2.5-2.7	8	Green out	128-130
4	Gnd	0	9	Blue out	130-137
5	Black current output	4.5-5.5			

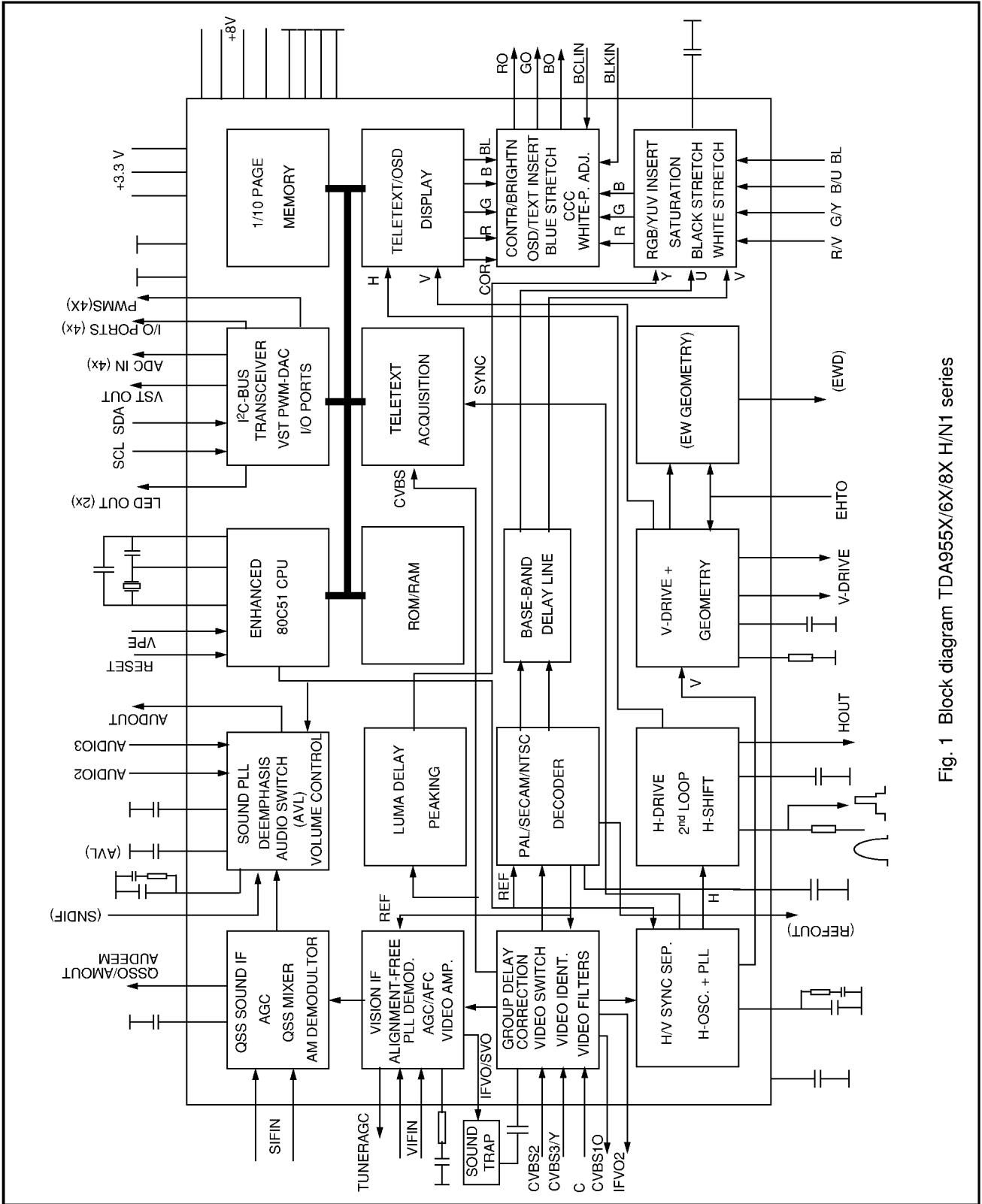

Fig. 1 Block diagram TDA955X/6X/8X H/N1 series



## PIN VOLTAGES OF SOME TRANSISTORS

### 1. PH601 (PC127FY) PHOTOCOUPLER

Pin	Standby VDC	ON VDC
1	12.5	11
2	11.5	10
3	5.5	5
4	8.8	12.3

### 2. T603 (BC848) NPN

	Standby VDC			TV ON VDC		
	B	C	E	B	C	E
<b>T603</b>	0.6	0.02	0	0.1	0.3	0

### 3. T604 (BC848) NPN

	Standby VDC			TV ON VDC		
	B	C	E	B	C	E
<b>T604</b>	0.02	12.7	0	0.7	0.05	0

### 4. T605 (BC848) NPN

	Standby VDC			TV ON VDC		
	B	C	E	B	C	E
<b>T605</b>	0.6	0.02	0	0.1	0.7	0

### 5. T606 (BC848) NPN

	Standby VDC			TV ON VDC		
	B	C	E	B	C	E
<b>T606</b>	0.6	0	0	1	6.8	0

### 6. T607 (BC848) NPN

	Standby VDC			TV ON VDC		
	B	C	E	B	C	E
<b>T607</b>	0.6	0	0	0.1	2.5	0

### 7. T307 (BC848) NPN

	Standby VDC			TV ON VDC		
	B	C	E	B	C	E
<b>T307</b>	0.6	0	0	0.1	15	0

# OSCILLOGRAPHS OF SOME IC PINS

**Note:** TV is connected to a pattern generator (Colour bar, sound 1 kHz).

## 1. IC101 (TDA956X)

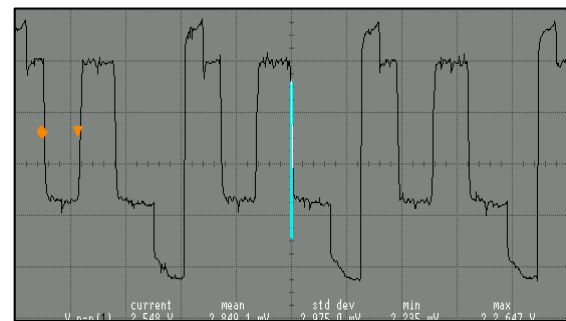
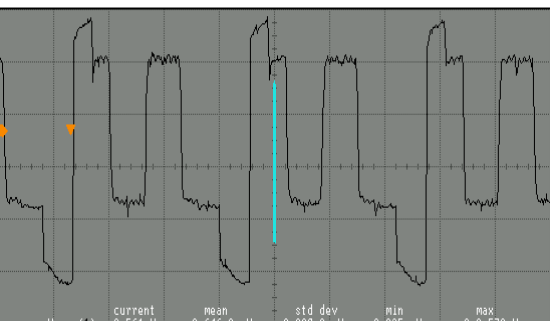
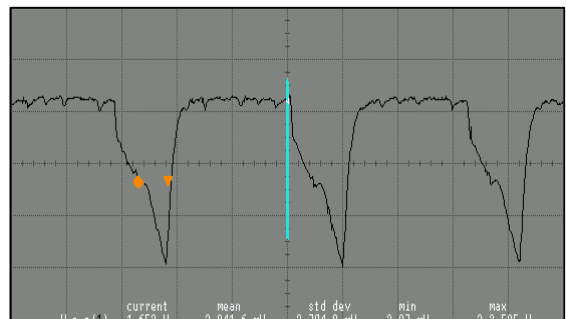
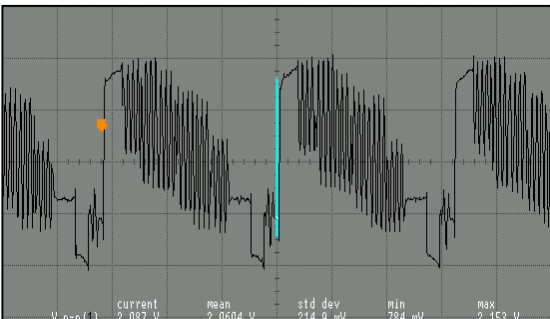
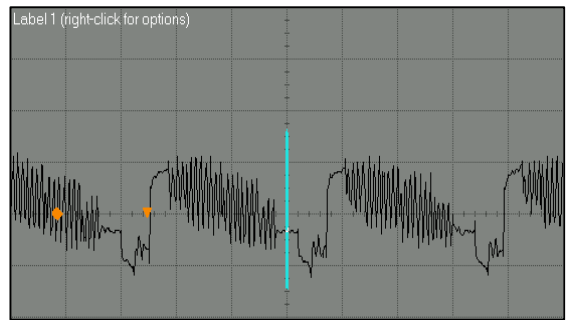
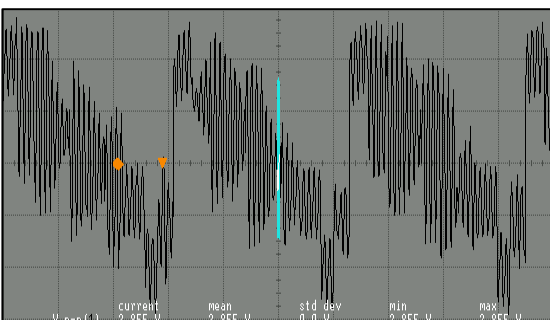
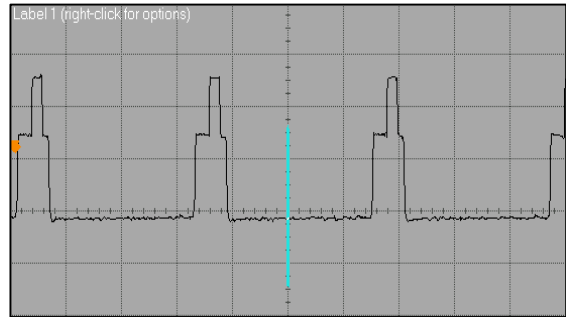
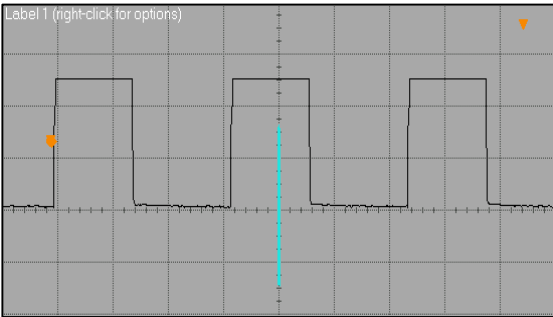

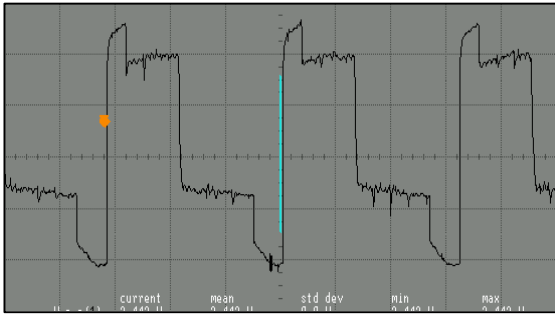

**Pin 58**

500 mV/div, 20 usn/div, Vpp=2.4 V, 15625 kHz

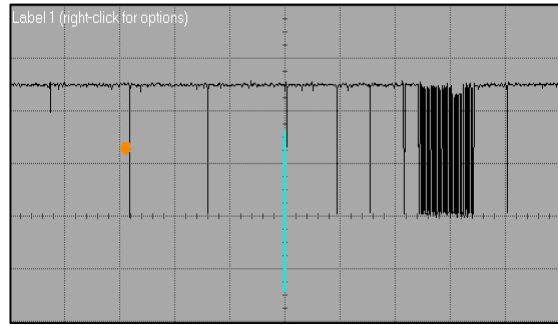

**Pin 71**

2 V/div, 1 msn/div, Vpp=5.2 V

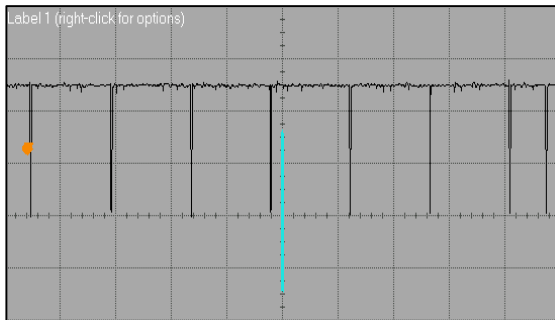

**Pin 72**

2 V/div, 1 msn/div, Vpp=5.2 V

## 2. IC301 (MSP34XX)

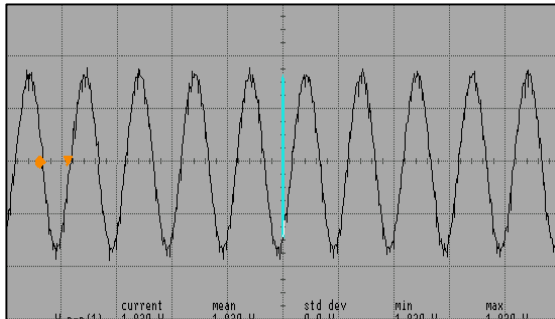

**Pin 28**

500 mV/div, 1 msn/div, Vpp=1.8 V

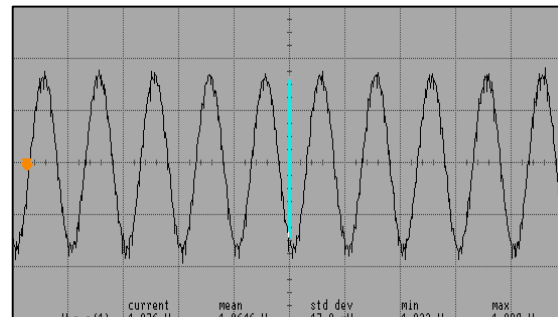

**Pin 29**

500 mV/div, 1 msn/div, Vpp=1.8 V

## 3. IC501 (TDA835X)

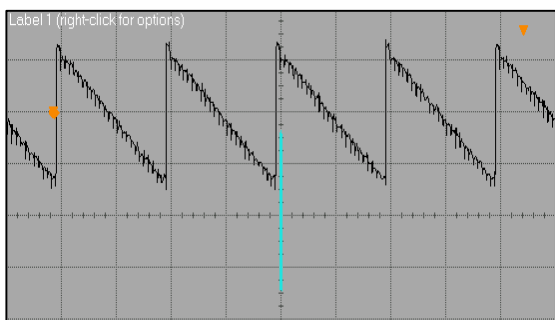

**Pin 1**

500 mV/div, 10 msn/div, Vpp=1.4 V, 50Hz

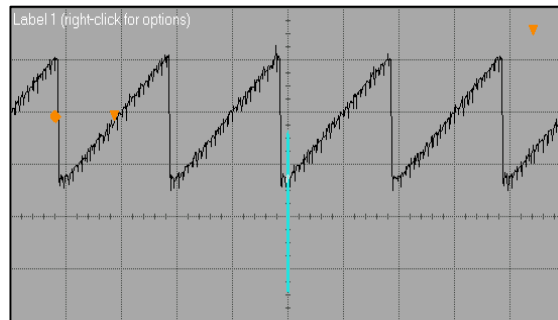

**Pin 2**

500 mV/div, 10 msn/div, Vpp=1.4 V, 50Hz

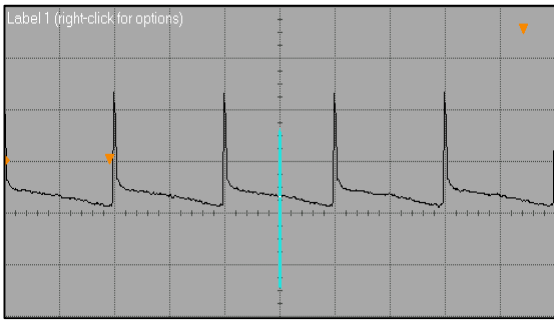

**Pin 7**

500 mV/div, 10 msn/div, Vpp=44.6 V, 50Hz

#### 4. T501 (2SK2381)

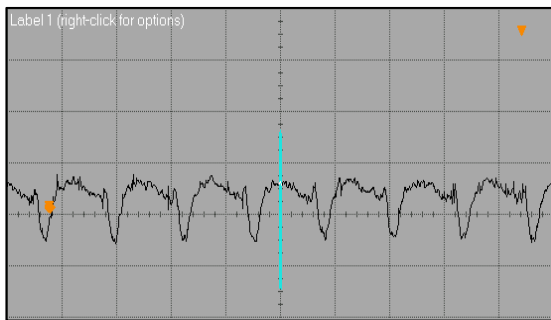

**Gate (EW drive)**

200 mV/div, 50 usn/div, Vpp=268 mV, 15625 Hz

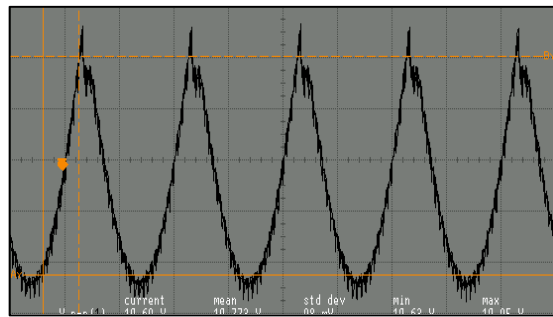

**Drain (EW drive)**

2 V/div, 10 usn/div, Vpp=10.7 V, 50 Hz

# 1. ELECTRICAL ADJUSTMENTS

## 1.1. Supply Voltage Adjustment

Connect a digital voltmeter to the cathode of diode D611 at the AV1 mode of the TV and set the screen voltage to the minimum with the screen potentiometer. Adjust the main supply voltage (B+) with P601 potentiometer to the following value (after adjustment, readjust Screen voltage).

21" Pure Flat	: 132 VDC
25"	: 145 VDC
28"	: 145 VDC (147 VDC for A66EAK071X11)
28" Pure Flat 16/9	: 140 VDC
28" Super Flat 16/9	: 140 VDC
29" Pure Flat	: 125 VDC
29" Super Flat	: 125 VDC
32" Pure Flat 16/9	: 140 VDC
32" Super Flat 16/9	: 131 VDC
33"	: 158 VDC

## 2. SERVICE ADJUSTMENTS

You need the special service remote control to enter and exit the service menu of the TV (you can order it from the manufacturer). All buttons of the Service RC are same with the user remote control, only service menu In / Out is added to it (please see the picture below).

### Navigation

Service In/Out : Enters to / exits from the Service Menu

P+ / P- : Moves upward / downward inside the menu

V+ / V- : Changes the values or options

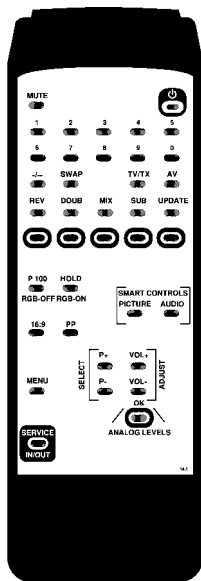

### 2.1. AGC Adjustment

- Apply an RF signal with amplitude  $70 \pm 1$  dBuV to the antenna input of TV with a pattern generator (switch sound carrier to Off and switch "Video Ext" to On).
- Switch on the Service Menu with the Service RC and find the AGC with P+ / P- buttons. Measure the 38.9 MHz signal on pin 11 (IF) of Tuner with an oscilloscope.
- Adjust "AGC" to get following values:
  - PAL BG, PAL SECAM BG, PAL SECAM BG-DK, PAL I versions :  $840 \pm 20$  mVpp
  - PAL SECAM BG-LL version :  $600 \pm 20$  mVpp
  - PAL BG MONO, PAL SECAM BG MONO :  $750 \pm 20$  mVpp
  - PAL I MONO :  $900 \pm 20$  mVpp
- Subtract 5 from "AGC" value and change "TEST" to this value.
- Exit from the service menu with the Service RC.

## 2.2. Screen Adjustment

Adjustment is change according to SW versions. New SW versions start from SB8643\_A05, SB8643\_B04, SB8643\_C04, SB8643\_D04, SB8645\_A05, SB8645\_B04, SB8645\_C03 and SB8645\_D04.

- If CRT brand is Philips and SW is old version, then Set Brightness value to "00" in the Picture menu and store.
- Enter the Service Menu with the Service RC and select "SCRN" option with P+ / P- buttons and switch to ON with V+ / V- button.  
For new SW versions (or Philips CRT) "BRI 00" is shown on the screen.  
For old SW versions "BRI 32" is shown on the screen.
- Adjust the screen potentiometer to the level where the screen is just black.
- By pressing one of V+ / V- buttons, get the picture (SCRN is switched to Off).
- Exit from the Service menu.
- If CRT brand is Philips and SW is old version, Set Brightness value to "32" in the Picture menu and store.

## 2.3. Geometry Adjustments

- Apply a Cross Hatch Test pattern.
- Enter Service Menu with Service RC and select "VSLP" option with P+ / P- buttons (In this option, the upper half part of the pattern is shown and lower half part is blanked).
- Adjust VSLP such that middle line of the pattern is cut.
- For 16/9 sets, adjust VZOM to 25. On 4/3 sets, when VZOM is selected, set switches to 16/9 mode. In this case, adjust the circle of the pattern just touches to the upper and lower edges. Re adjust the VSLP if required.
- Adjust vertical position with VSHT, vertical linearity with SCOR and vertical height with VAMP.
- For 4/3 sets, adjust the horizontal amplitude with EWW.  
For 16/9 sets, adjust the 16/9 horizontal amplitude with EWW1 and 4/3 horizontal amplitude with EWW (EWW value is 21 lower than EWW1 value).
- For 16/9 sets, find the VZM1 option and adjust such that second lines from top and bottom just touches to the edges.
- Adjust horizontal centering with HSHT, parabola with EWPW and trapezium with EWT.
- For 4/3 sets, adjust the 16/9 general parabola with EWP1.
- Adjust the upper corner parabola with EWCU and lower corner parabola with EWCL, vertical parallelogram with HPAR, horizontal bow with HBOW.

**For PIP versions :** Select "PIP PRESS OK" and press "OK" button in the service menu. Adjust "HORPOS0" for horizontal shift of PIP window, "VERPOS0" for vertical shift of PIP window (press "POS" button to place PIP to the left-top corner), "HORPOS1" for 12-window PIP horizontal shift, "HORPOS2" for 11-window PIP horizontal shift, "HORPOS4" for right PIP horizontal shift.

## 2.4. White Balance Adjustment

- Enter the Service Menu with the Service RC and select "GRN" option with P+ / P- buttons and adjust it to "32" V+ / V- button.
- Adjust RED and BLUE for white balance. If white balance can not be adjusted properly change GRN value.
- Adjust BLOR and BLOG for red and green cut off.
- Exit from the Service menu.

## 2.5. Feature Options

Tuner	: Panasonic, Phillips, Sharp, Temic
STD	: STBY-On (Default, Automatic switch off is active), STBY-Off (can be used during repair)
Head	: Yes (Headphone available), No
SCRN	: Off, On (used for screen adjustment)
AV	: 01 (1 Scart), 03 (2 Scarts), 04 (2 Scarts + Front AV), 05 (2 Scarts + Front AV+ SVHS)
SSTD	: BG only, I only, BG+DK, BG + LL', All SYS
STYP	: NICAM On (available), NICAM Off
Toptext	: Yes (available), No
Fasttext	: Yes (available), No

TXT table : West (West Europe), East (East Europe), Cyrillic, Arabic, Hebrew, Greek  
A type SW includes East, West, Greek. B type SW includes East, West, Cyrillic, Arabic.  
C type SW includes East, West, Cyrillic, Hebrew. D type SW includes East, West, Cyrillic.

Hotel : On (Hotel Mode), Off (TV Mode)

Subwoofer : Yes (available), No

CRT : 4/3, 16/9

Peak1 : Yes (16/9 sets), No (4/3 sets)

AVV : Yes (Auto AV switching is active), No (Deactive).

PAL : Yes (PAL only versions), No (Other versions)

SAWF <sup>1)</sup> : 01 (PAL BG, PAL-SECAM BG, PAL I or PAL-SECAM BG-DK without FTZ)  
02 (SECAM LL' or PAL-SECAM BG-DK with FTZ)

<sup>1)</sup> Available in only SW versions of Mono versions.

## 2.6. Factory Settings for Service Mode

1. Values given in Table 1 are typical values and can vary according to the CRT type.
2. PF means Pure Flat and SF means Super Flat.
3. The values in the table are decimal and shown in paranthesis on the OSD of TV.

		21" PF	25" 28" 16/9	28" 16/9 PF	28" 16/9 SF	29" PF	29" SF	32" 16/9 PF	32" 16/9 SF	33"
AGC	Automatic gain control	14	14	14	14	14	14	14	14	14
EEPE	Reset the eeprom, all values lost	00	00	00	00	00	00	00	00	00
PEAK	Peaking	32	32	32	32	32	32	32	32	32
GRN	Green level	32	32	32	32	32	32	32	32	32
RED	Red level	40	40	35	35	32	35	40	40	42
BLUE	Blue level	34	34	32	33	26	33	34	34	34
BLOG	Black level offset green	32	30	28	30	25	30	31	31	27
BLOR	Black level offset red	40	36	41	40	33	40	41	41	37
YDLY	Luminance delay	04	04	04	04	04	04	04	04	04
SAT	Saturation	20	20	20	20	20	20	20	20	20
HUE	Sharpness	32	32	32	32	32	32	32	32	32
CON	Contrast	40	40	40	40	40	40	40	40	40
CDR	Cathode Drive Level	04	05	04	04	05	05	04	04	05
BRI	Brightness	32	32	32	32	32	32	32	32	32
EWT	East West Trapezium	28	28	17	24	28	27	24	24	26
EWCU	EW upper corner	40	32	22	14	32	39	07	07	27
EWCL	EW lower corner	55	32	48	38	38	42	22	22	37
EWPW	EW parabola width	04	17	08	08	14	12	12	12	20
HSHT	Horizontal shift	38	35	35	40	31	29	29	29	35
EWV	East West Width	60	60	37	36	55	57	39	39	62
VAMP	Vertical amplitude	48	46	42	42	43	45	45	45	48
SCOR	S correction	30	25	25	17	31	25	17	17	25
VSHT	Vertical shift	24	29	27	28	28	26	31	31	25
VSLP	Vertical slope	27	32	32	32	34	29	35	35	32
RGB <sup>1)</sup>	OSD brightness level	01	01	10	10	01	01	10	10	01
VZOM	Vertical zoom	39	39	39	39	39	39	39	39	39
PWLT	Peak white limiting	06	11	06	06	11	11	06	06	11
IFOF	Offset IF demodulator	32	32	32	32	32	32	32	32	32
HPAR	Horizontal parallelogram	48	32	32	32	32	32	32	32	32
HBOW	Horizontal bow	32	32	32	32	32	32	32	32	32
TEST	Added for EMC purposes (=AGC-5)	09	09	09	09	09	09	09	09	09
EWPI	16/9 EW parabola width (for only 4/3 sets)	02	08	05	05	09	09	05	05	13
EWV1	East West Width (for only 16/9 sets)	-	-	58	57	-	-	60	60	-
VZM1	Vertical Zoom (for only 16/9 sets)	-	-	58	59	-	-	59	59	-

Table 1

<sup>1)</sup> For old SW versions (see section 2.2) RGB value is "01". For new SW, RGB is "01" for 4/3 and "10" for 16/9 sets.

## 2.7 Software Versions

During exit from service menu, the software version and feature options (hexadecimal number) are shown on the screen. For example: SB8643\_X05, C697H.

Stereo software versions of 14.2 are named as follows:

SB8643\_X.. for TDA9563 (intercarrier)

SB8645\_X.. for TDA9565 (QSS)

Mono Software versions are named as follows:

SC3325-X.. for TDA9555H (only QSS)

PIP Software versions are named as follows:

SB8963\_X.. for TDA9563 (intercarrier)

SB8965\_X.. for TDA9565 (QSS)

".." shows version number (for example 05).

"X" shows OSD language group.

OSD Languages per group are given below:

	<u>GROUP A</u>	<u>GROUP B</u>	<u>GROUP C</u>	<u>GROUP D</u>
1.	ENGLISH	ENGLISH	ENGLISH	ENGLISH
2.	GERMAN	FRENCH	GERMAN	RUSSIAN
3.	FRENCH	POLISH	TURKISH	SERBIAN
4.	ITALIAN	HUNGARY	SWISS	BULGARIAN
5.	SPANISH	SLOVAK	DANISH	ROMANIAN
6.	PORTUGAL	CZECH	NORWEGIAN	MACEDONIAN
7.	DUTCH	IRAN	FINNISH	CROATIAN
8.	GREEK	ARABIAN	HEBREW	SLOVENIAN



## POWER SUPPLY DEFECTS (I)

**Note:**

1. All values in the diagrams are for 230 VAC mains supply.
2. Before replacing T601, check following components: R640, R604, R605, R609, C615.
3. Burst type standby mode was designed (Fixed frequency is 21.5 kHz for standby and 38.8 kHz for normal operation). In standby the output voltages drop to about 1/10 of the normal operation values (except +12V which stays same), i.e. from +145V to 14.7V, from 15V to 1.1V, from 28V to 2.5V. In standby, Standby signal from IC101 is high. Then, T605 conducts, T604 blocks and thristor TH601 conducts. Therefore, +145 line which is now 14.7V is connected to 12V. The regulation is done by ZD603 in standby and by ZD602 (TL431) in normal mode.

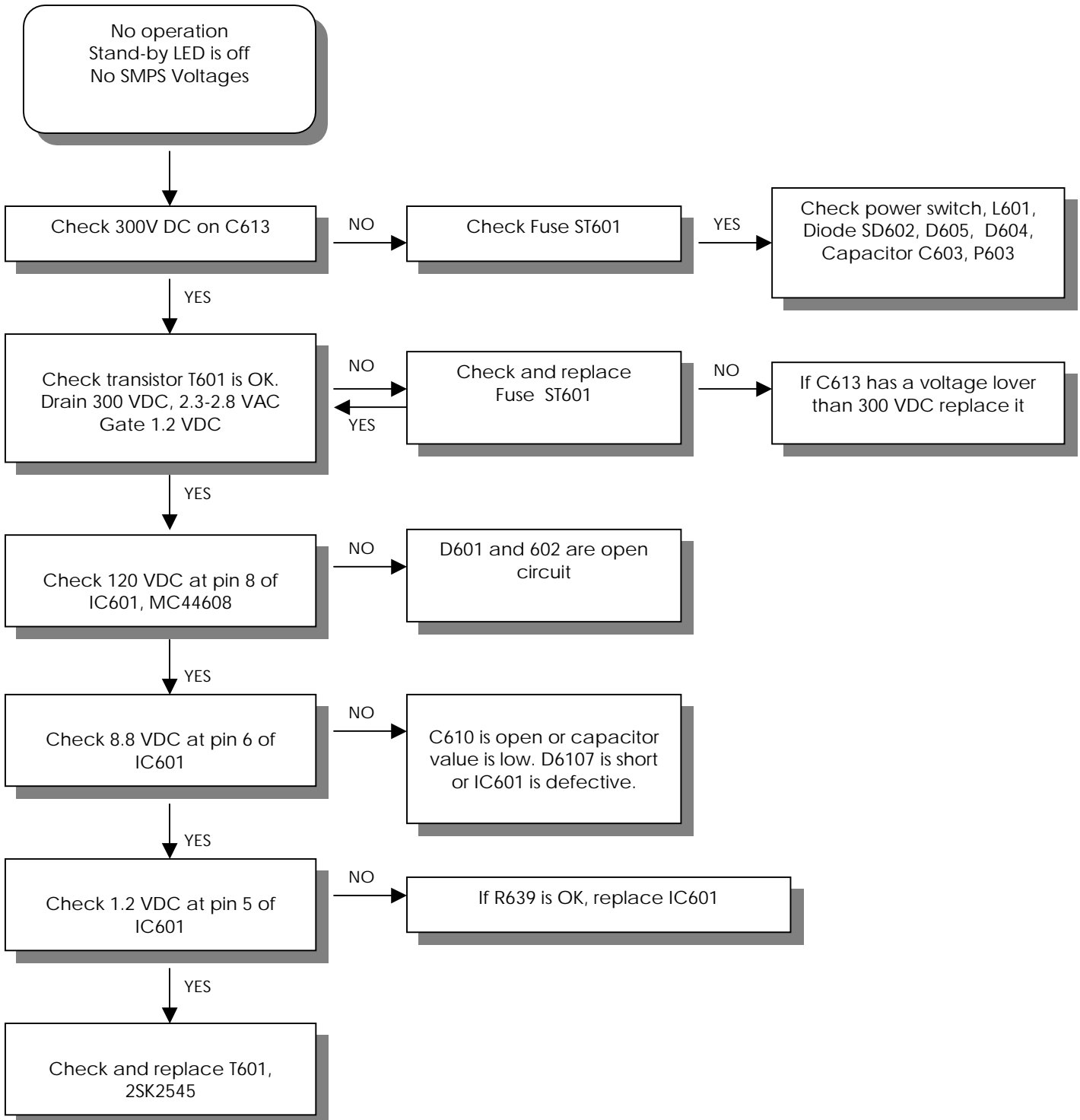

## POWER SUPPLY DEFECTS (II)

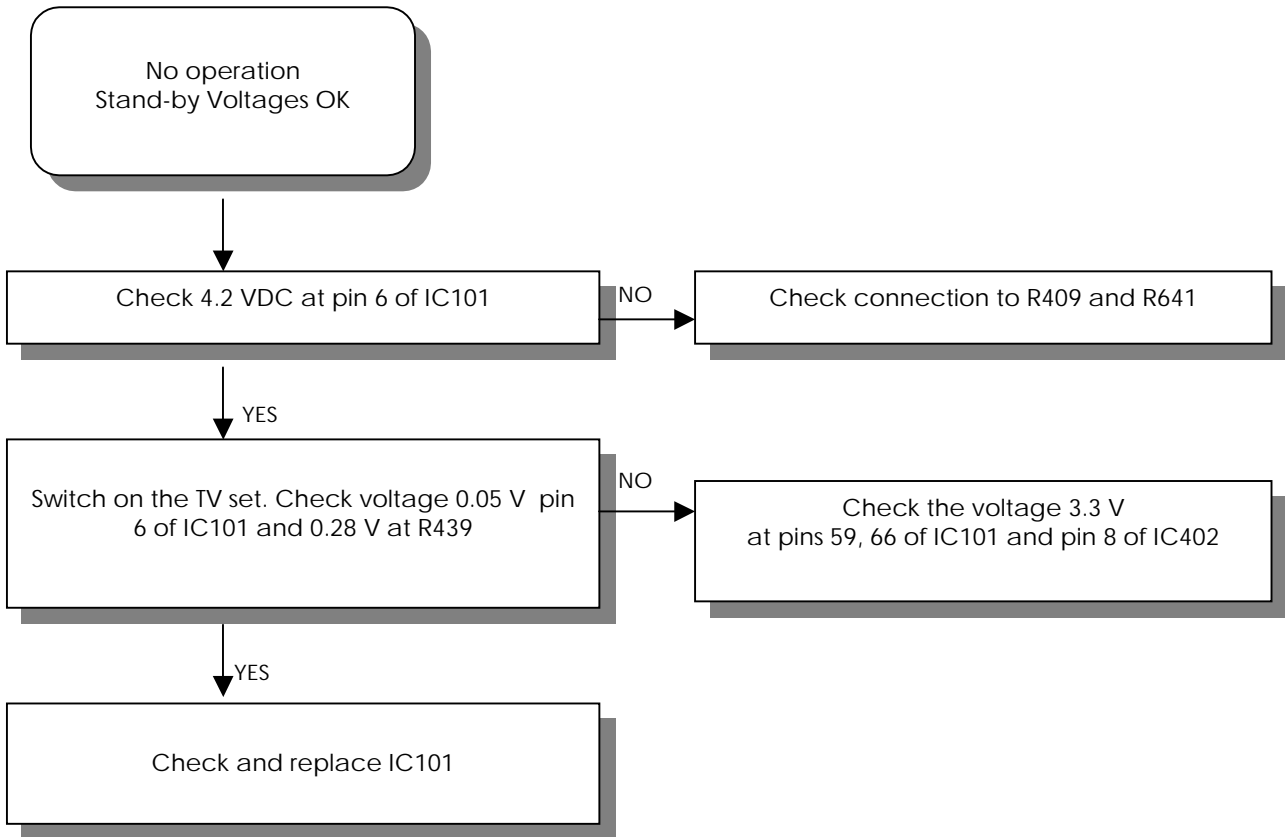

## POWER SUPPLY DEFECTS (III)

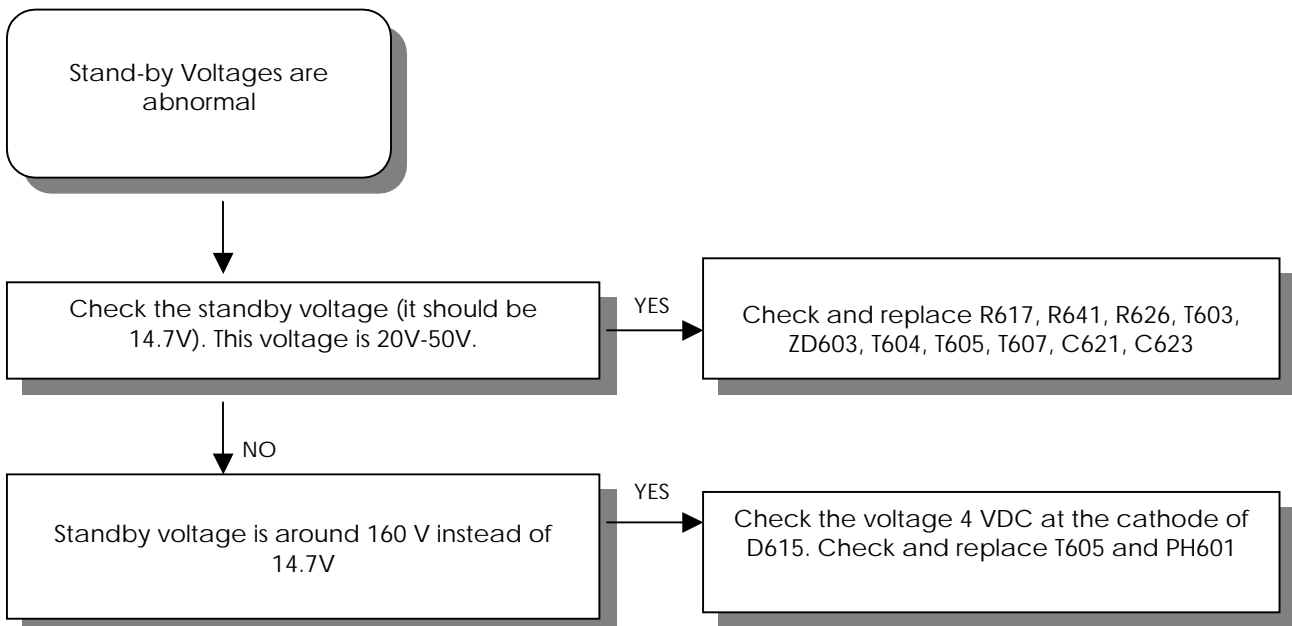

## POWER SUPPLY DEFECTS (IV)

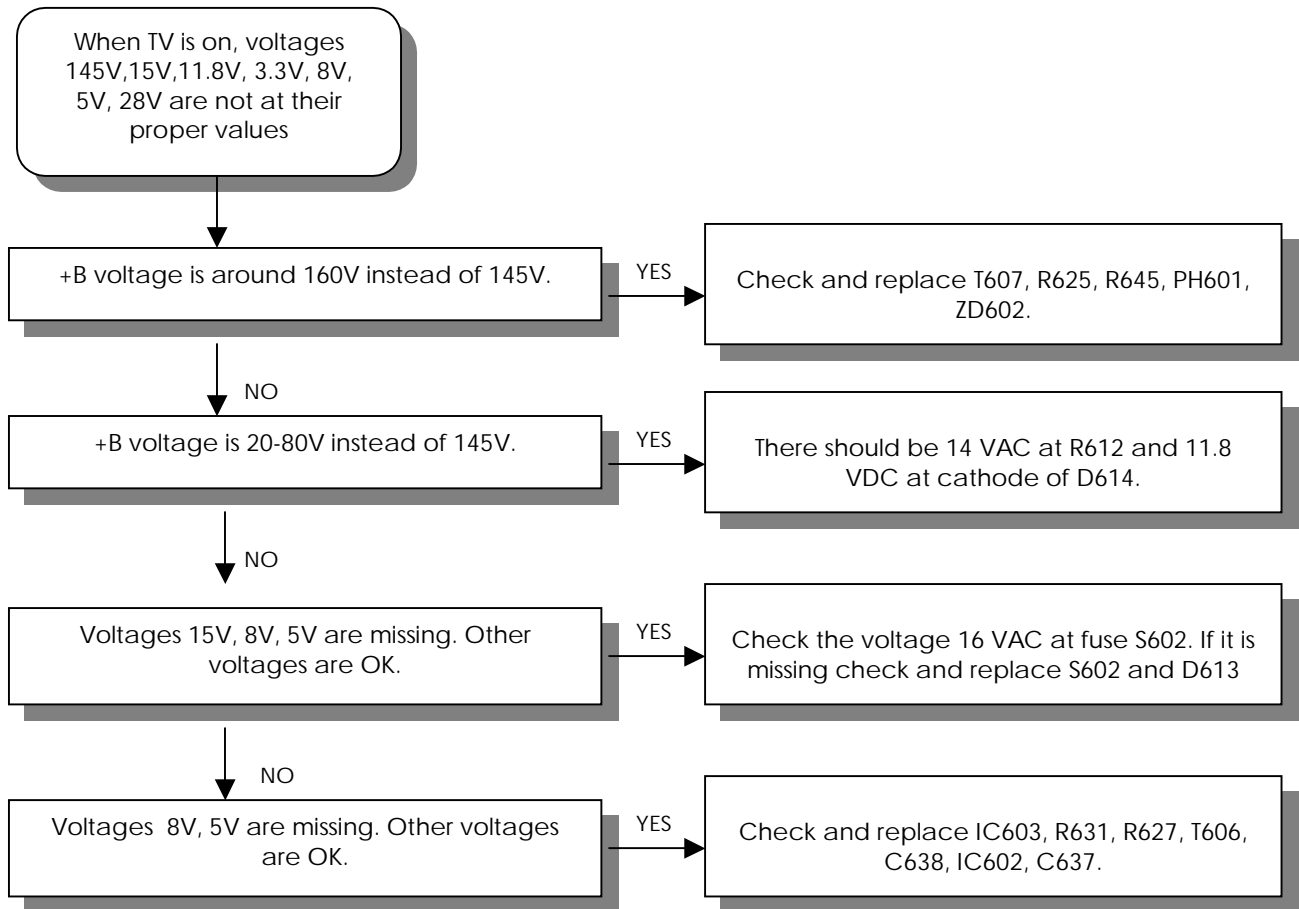

## PICTURE AND COLOUR DEFECTS

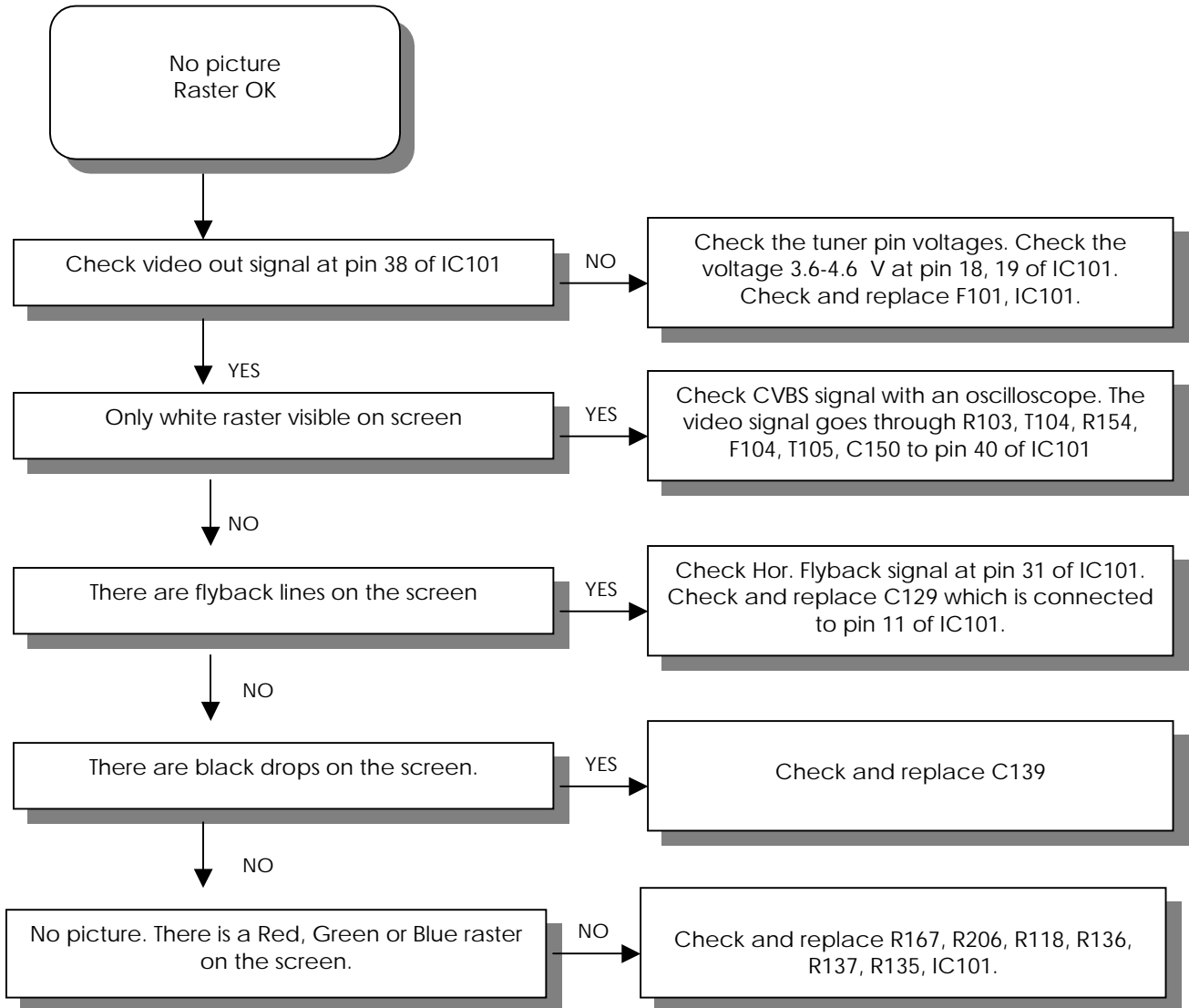

## HORIZONTAL DEFLECTION CIRCUIT DEFECTS

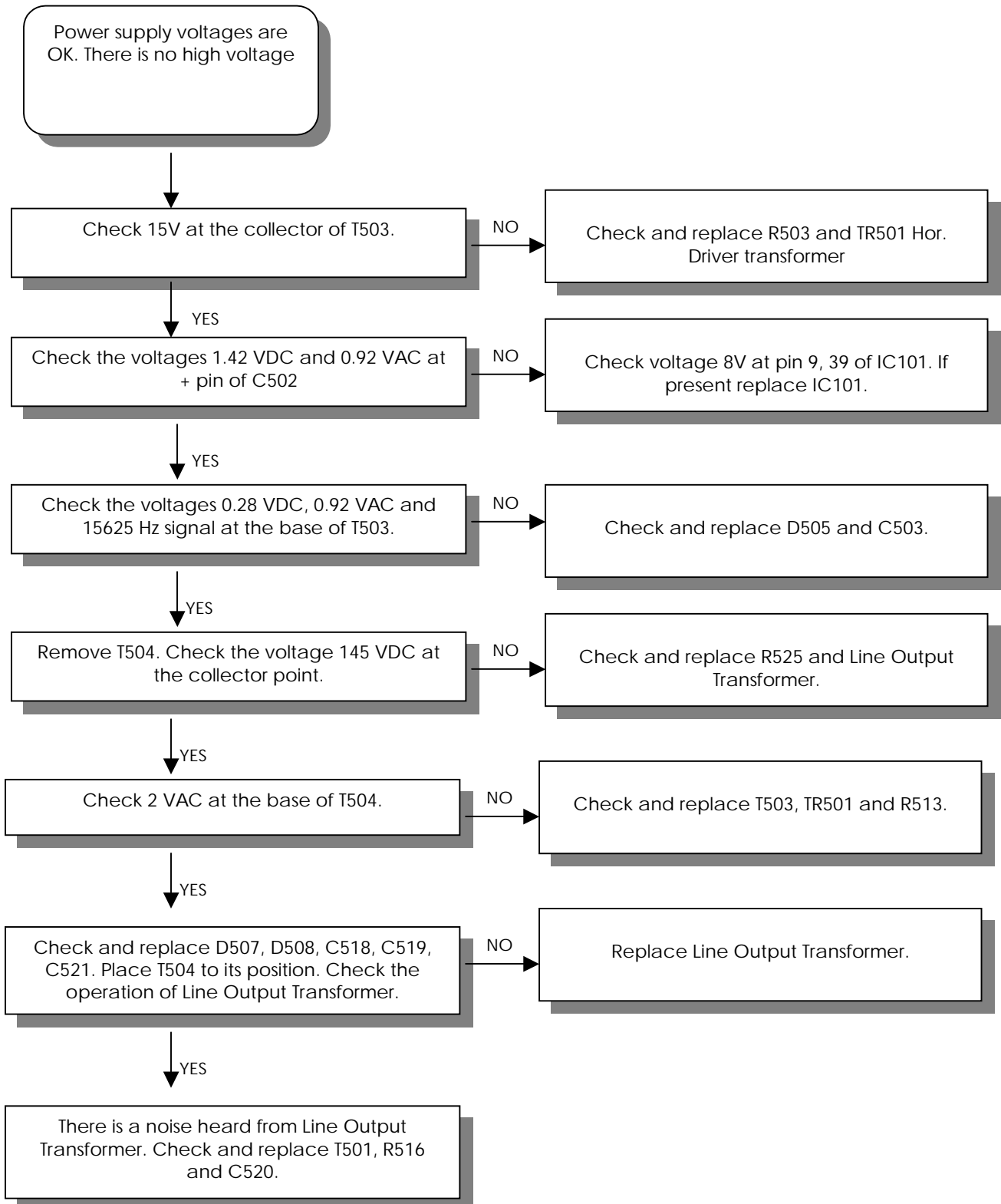

## VERTICAL DEFLECTION CIRCUIT DEFECTS

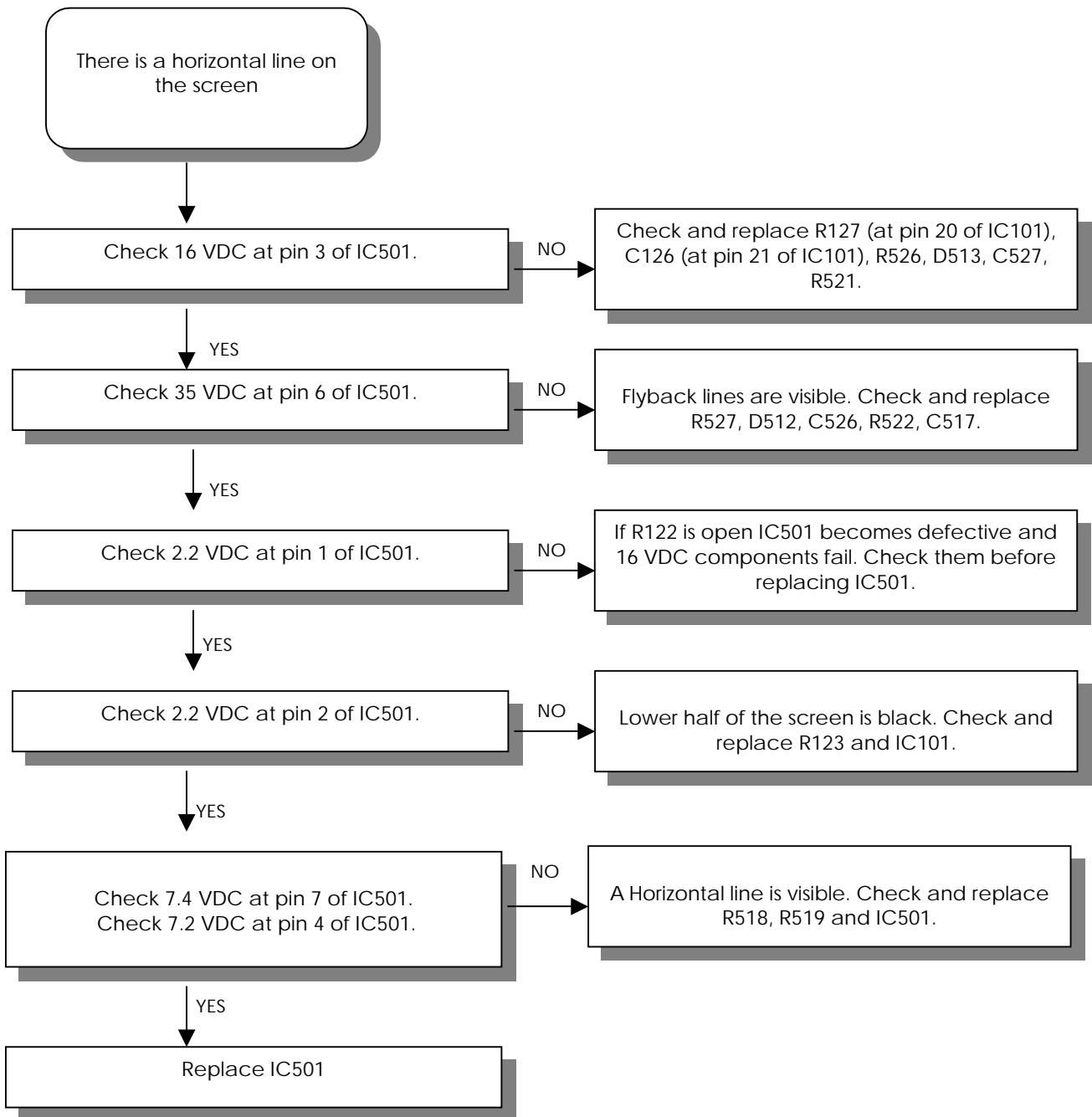

## AUDIO DEFECTS (I)

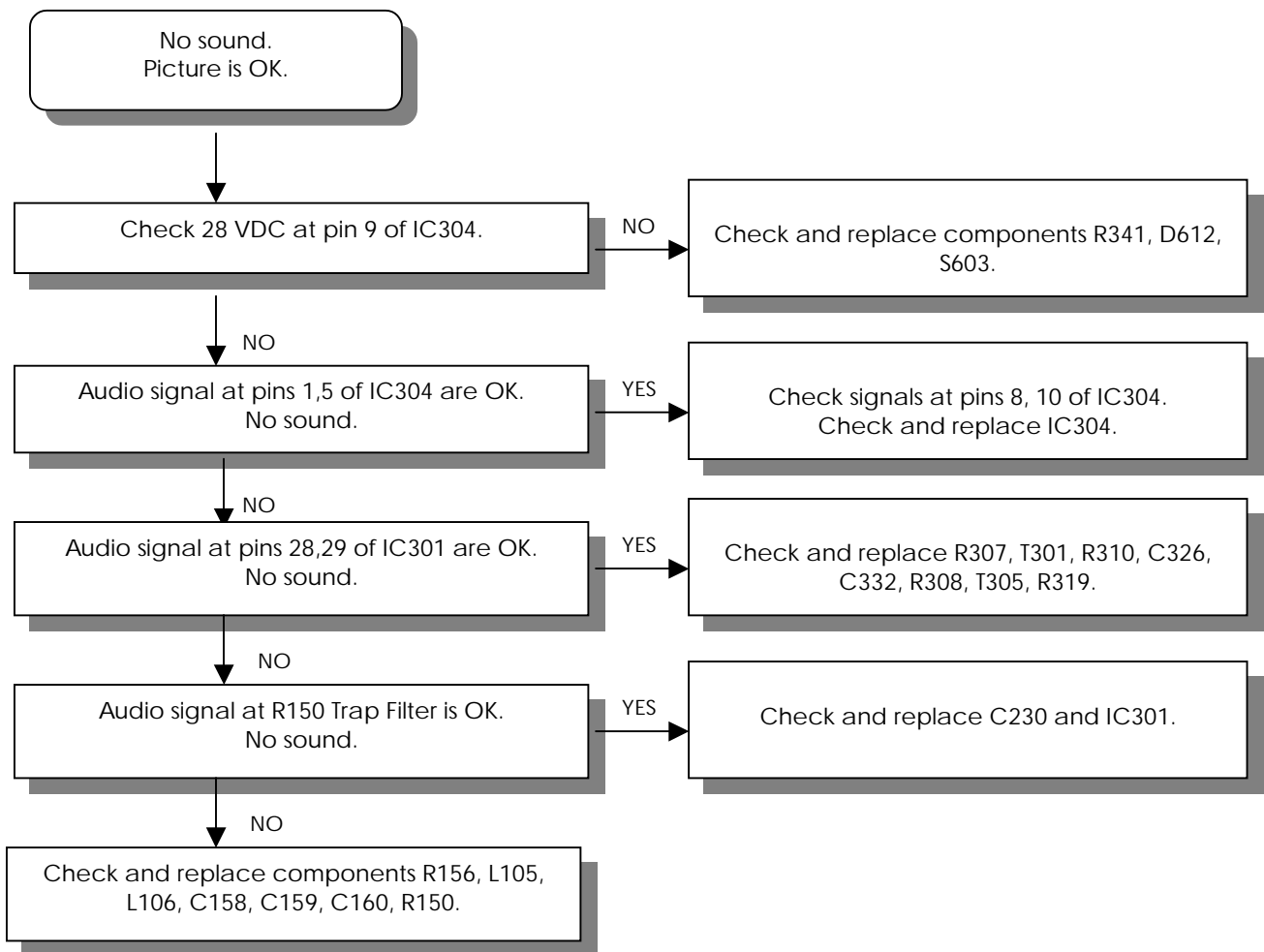

## AUDIO DEFECTS (II)

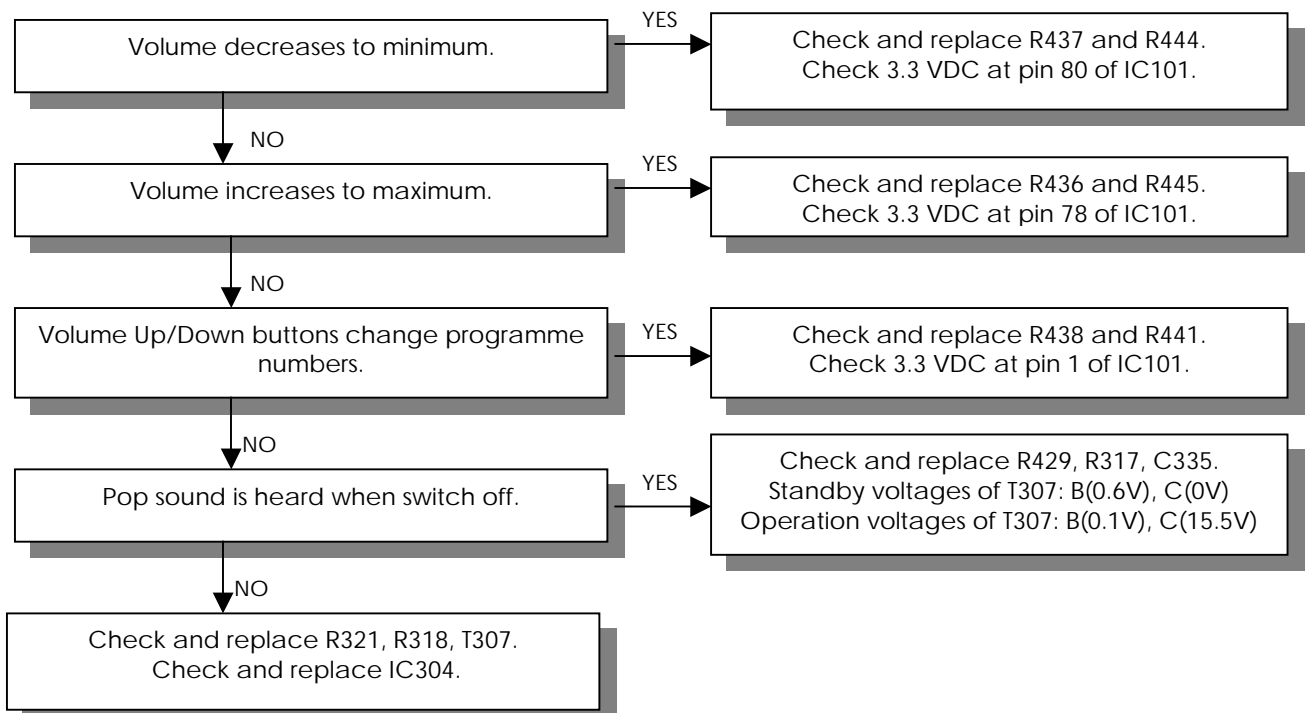

## PARTS LIST

PART NO	DESCRIPTION	NOTES	POSITION NUMBERS
291103	CC-CHIP 100PF J 50V /0805 N		C101 C111
293108	CC-CHIP 10NF K 50V /0805 X7		C103 C149
290473	CC-CHIP 47PF J 50V /0805 NP		C104 C107
252112	EC 100UF 16V 11*6 R:5		C105
250113	C-ELA 1UF 25V 11*5 R:5	MONO SOUND	C108
292334	CC-CHIP 3.3NF K 50V /0805 X7R	1. MONO SOUND	C109
250111	EC 1UF 16V 11*5 R:5		C110
292479	CC-CHIP 4.7NF K 50V /1206 X		C112
293230	CC-CHIP 22NF K 50V /0805 X7		C118 C120
250470	C-ELA 4.7UF 16V 11*5 R:5	MONO SOUND	C123
259223	EC 2.2UF 63V 11*5 R:5		C124 C139 C507
294231	CC-CHIP 220NF K 16V /0805 X		C125
274107	C-PEM 100NF J 100V R:5		C126
290561	CC-CHIP 56PF J 50V NPO 0805		C131 C165
290222	CC-CHIP 22PF J 50V /0805 NP		C136
250111	C-ELA 1UF 16V 11*5 R:5	MONO SOUND	C142 C166
291822	CC-CHIP 820PF J 50V /0805 NPO	MONO SOUND	C144
294476	CC-CHIP 470NF K 16V /0805 X		C145
251107	EC 10UF M 16V 11*5 R:5		C146 C148 C162 C167 C638
294475	CC-CHIP 470NF M 25V /1206 Z		C151
291822	CC-CHIP 820PF J 50V /0805 N		C158 C160
292479	CC-CHIP 4.7NF K 50V /1206 X7R	MONO SOUND	C178
290684	CC-CHIP 68PF J 50V /0805 NP		C186
291225	CC-CHIP 220PF K 50V /0805 X		C202 C203
291473	CC-CHIP 470PF K 50V /0805 X		C209 C366
291474	CC-CHIP 470PF J 50V /1206 N		C214 C210
251478	EC 47UF 16V 11*5 R:5		C217 C221 C224 C302 C314
250470	EC 4.7UF 16V 11*5 R:5		C220 C222 C226 C225
294111	CC-CHIP 100NF K 25V /0805 X		C229 C235
294331	CC-CHIP 330NF K 16V /0805 X		C239 C241
299152	CC-CHIP 1.5PF C 25V/0805		C308 C313
292110	CC-CHIP 1NF K 50V /0805 X7R		C322 C324
250227	EC 2.2UF 16V 11*5 R:5	EXT.SPEAK.	C330A
292105	CC-CHIP 1NF K 50V /1206 X7R		C332 C334
253101	EC 1000UF 35V 25*13 R:5		C338 C340
252229	EC 220UF 16V 11*8 R:5	EXT.SPEAK.	C344 C346
252112	EC 100UF 16V 11*6 R:5		C352 C353 C337 C401 C402
253106	EC 1000UF 25V 20*13 R:5		C354 C355 C620
291477	CC-CHIP 470PF J 50V /0805 N		C405 C406
290334	CC-CHIP 33PF J 50V /0805 NP		C413
272101	C-PEM 1NF K 50V R:5		C503
251478	EC 47UF 16V 11*5 R:5		C504 C639
274230	C-PEM 220NF J 100V R:5		C505 C524 C523
200680	CC 68PF J 500V NPO R:5		C506
292223	CC-CHIP 2.2NF K 50V /0805 X		C508 C509
252476	EC 470UF 25V 11*10 R:5		C512 C527
272154	C-PPM 1.5NF J 1600V R:15	25",28"4/3	C513
272103	C-PPM 1NF J 2KV R:15	28"16/9	C513
271331	C-PPM 330PF J 1500V/1600V R	21"PF, 32"	C513
294109	CC-CHIP 100NF K 50V /0805 X		C515 C516
273104	C-PPM 10NF J 1.5/1.6KV R:22	25",28"4/3	C518
273114	C-PPM 10NF J 1.5/1.6KV R:15	21" PF	C518
273119	C-PPM 11NF J 1.5/1.6KV R:22	33"	C518
273120	C-PPM 12NF J 1.5/1.6KV R:22	28"16/9	C518
273131	C-PPM 13.1NF J 1.5/1.6KV R:	29",32"	C518
273151	C-PPM 15NF J 1KV R:15	16/9 sets	C519
273228	C-PPM 22NF J 1KV R:15	4/3 sets	C519
273331	C-PPM 33NF J 1KV R:15	21" PF	C519
274563	C-PPM 560NF J 250V R:15		C520 C521
274563	C-PPM 560NF J 250V R:15	21",25",32",28"4/3	C521



## PARTS LIST

PART NO	DESCRIPTION	NOTES	POSITION NUMBERS
274684	C-PPM 680NF J 250V R:15	33"	C521
274684	C-PPM 680NF J 250V R:15	28"16/9	C521
250100	EC 1UF 160V 11*6.3 R:5		C522
251225	EC 22UF 16V 11*5 R:5		C528
272110	C-PEM 1NF J 100V R:5		C529
274224	C-PEM 220NF K 275V-AC R22. 		C601 C602
274105	C-PEM 100NF J 250V R:10		C603 C701
202105	CC 1NF K 1KV Y5P R:5		C604 C605 C607 C608
274102	C-PEM 100NF J 63V R:5		C606
252150	EC 150UF 400V 40*22 R:10		C613
201471	CC 470PF 2KV		C614 C619
203330	C-PPM 33NF J 630V R:15		C615
202220	CC 2.2NF M 250VAC Y5U R:10 		C616
253101	EC 1000UF 35V 25*13 R:5		C621
293681	CC-CHIP 68NF K 25V /0805 X7		C624
293474	CC-CHIP 47NF K 50V /0805 X7		C625 C626
252104	EC 100UF 200V 25*16 R:7.5		C629 C627
251228	EC 22UF 200V 11.5*8 R:5		C629
201108	CC 100PF 500V NPO R:5		C631
294108	CC-CHIP 100NF K 50V /1206 X		C632 C326
293332	CC-CHIP 33NF K 50V /0805 X7		C634
293475	CC-CHIP 47NF K 50V /1206 X7		C636
251120	EC 10UF 10V 5*4 R:5		C637 C901
251109	EC 10UF 250V 16*10 R:5		C702 C703
273225	C-PEM 22NF J 63V R:5		C704
202221	C-CE 2.2NF K 2KV Y5P R:7.5		C705
202106	CC 1NF K 50V Y5P R:5	SVHS	C920 C921 C922 C923
273471	C-PEM 47NF K 63V R:5		C940 C941
201472	CC 470PF K 50V SL R:5	EXT.SPEAK.	C962 C963
291101	CC-CHIP 100PF J 50V /1206 N		C981 C982
303195	DIODE 4148 MELF	LL'	D102
303223	DIODE-CHIP BA682 SOD80	LL'	D103 D104
302296	DIODE 1N4148 26MM		D401 D402
302289	DIODE 1N4148 52MM		D401 D402 D505
303195	DIODE 4148 MELF		D503 D504
303109	DIODE ERC06-1500		D507
303244	DIODE RGP30K		D508
302948	DIODE 1N4007		D509 D701
300305	DIODE BA157		D510 D511 D512
303227	DIODE RGP15J		D513
303209	DIODE BAV21		D515 D702 D703 D704
303217	DIODE RGP10J		D601 D615
303308	DIODE RF2007		D602 D603 D604 D605
303215	DIODE RGP10G		D607 D614
303214	DIODE UF4006		D608 D609
303206	DIODE RGP30MS		D611
303228	DIODE RGP30D		D612 D613
303988	LED LTL 4224 RED (SHORT LEG	28"	D901
303942	LED LTL4224 RED	25"	D901
303900	LED ROT	21",29",32",33"	D901
303993	LED LTL4221N D:3 R/D RED		D980
303991	LED IR SIR563SB3F 23/940		D981
056749	SAW FILTER OFW G1985M	PAL BG	F101
056760	SAW FILTER OFW J1956M	PAL I	F101
056709	SAW FILTER OFW K3953M	PAL SECAM DK	F101
056708	SAW FILTER OFW K3958M	SECAM LL'	F101
056767	SAW FILTER OFW K9456M	SECAM LL'	F102
056721	SER.FILTER TPS5.5MWA	PAL SECAM BG DK	F104

## PARTS LIST

PART NO	DESCRIPTION	NOTES	POSITION NUMBERS				
56709	SAW FILTER OFW K3953M	PIP	F801				
056745	SER.FILTER TPS6.0MB	P I	F104				
053740	COIL 1UH K LAL03		F105				
056640-01	SER.FILTER MKT40.4MA110P-TF	DK	F105				
056744	SAW FILTER OFW G9353M	DK	F106				
056640-01	SER.FILTER MKT40.4MA110P-TF	LL'	F108				
458642	IC-CHIP TDA9563H/N1/3	BG,I (STEREO INTERCARRIER)	IC101				
458643	IC-CHIP TDA9565H/N1/3	BG/DK, LL' (STEREO QSS)	IC101				
458321	IC-CHIP TDA9555H/N1/11 (32K	MONO QSS	IC101				
458964	IC-CHIP TDA9563/H/N1/I/4	PIP (INTERCARRIER)	IC101				
458965	IC-CHIP TDA9565/H/N1/I/4	PIP (QSS)	IC101				
452510	IC 4053B CMOS 16SOIC		IC102				
452575-01	IC MSP3400G	NON VIRTUAL DOLBY	IC301				
452800	IC MSP3410G PSDIP64 AUDIO P	NON VIRTUAL DOLBY, NICAM	IC301				
452595	IC MSP3411G	VIRTUAL DOLBY	IC301				
452374	IC L78L05 ACZ TR		IC302				
452368	IC TDA7262 PWR AMP SGS THOM	33"	IC304				
452482	IC TDA7263		IC304				
452784	IC-CHIP M24C08-WMN6 (EEPROM		IC401				
452976	IC TDA8359 J		IC501				
452487-01	IC MC44608P40		IC601				
451517	IC TDB7805CT T0220CASE		IC602				
451518	IC KA317TU T0220CASE		IC603	IC604			
50S310	INSULATOR BUZ90 17*12*.15		IC603				
452520	IC TDA6108JF		IC701				
451569	IC-CHIP TDA9886T/V3 118(SO24)	PIP	IC801				
451570	IC-CHIP SDA9489X SOP28	PIP	IC802				
451518	IC KA317TU T0220CASE	PIP	IC803				
452521	IR RECEIVER TSOP 1838		IC901				
452382	IC-CHIP S3C1840DA9/SMB1		IC980				
053711	COIL 10UH K (TAIYO) LAL03		L101	L301	L302	L401	L402
053719	COIL CHIP 1UH		L102	L105	L106		
053794	COIL CHIP 330NH /0805		L102				
053737	COIL-CHIP 8.2UH K /1206		L104				
053735	COIL-CHIP 18UH K /12		L201	L303			
051707	COIL 6MH E/W 11.1		L501				
051585	COIL H-LIN 70UH	21" PF	L502				
051605	COIL H.LINEARITE 39UH	25",29"	L502				
053330	COIL H.LINEARITE 45UH	28" 16/9	L502				
052692	COIL LINEARITY 30UH (TERMAL	28" 4/3, 32", 33"	L502				
051729	BRIDGE COIL 1.5MH	25",28"4/3,33"	L503				
051798-01	BRIDGE COIL 1.8MH	28"16/9,32"	L503				
051813	BRIDGE COIL 850UH	29"	L503				
051737	LINE FILTRE 2*18MH E-TYPE	⚠	L601				
053734	COIL 4.7UH LAL03		L603				
053739	COIL CHOKE 50UH		L604				
053352	COIL- CHOKE 10UH R0814 14.1		L701				
053500	BOBIN 10UH K AXIAL LAL04	PIP	L801	L803			
055139	CHOKE COIL 50MHZ 600R PH-WB		L962	L963			
055127	CORE FERRIT						
055597	FERRITE BEAD 12*8						
133118	R-VAR 10K V(2.5MM) 5*3	⚠	P601				
452408	IC PC123FY2PHOTO COUPLER		PH601				
056952	CRYSTAL 18.432MHZ +-30PPM		Q301				
056946	CRYSTAL 12MHZ		Q401				
056013	CRYSTAL 4 MHZ	PIP	Q801				
56161	CRYSTAL 20.25MHZ	PIP	Q802				

## PARTS LIST

PART NO	DESCRIPTION	NOTES	POSITION NUMBERS
056210	CER.RESONATOR GSB455E		Q980
172335	RC-CHIP 3.3K J 1/10W /0805	MONO SOUND	R103 R106
172683	RC-CHIP 6.8K J 1/10W /0805	MONO SOUND	R107
171471	RC-CHIP 470R J 1/10W /0805	MONO SOUND	R104
174151	RC-CHIP 150K J 1/10W /0805	MONO SOUND	R109
174473	RC-CHIP 470K J 1/10W /0805	MONO SOUND	R110
173154	RC-CHIP 15K J 1/10W /0805		R112
174104	RC-CHIP 100K J 1/10W /0805		R114
101683	CFR 680R J 1/4W /6 52MM		R124
172274	RC-CHIP 2.7K J 1/8W/1206 (T		R126
173392	RC-CHIP 39K %1 1/10W/0805		R127
171393	RC-CHIP 390R J 1/10W /0805		R129
172273	RC-CHIP 2.7K J 1/10W /0805	MONO SOUND	R130
173479	RC-CHIP 47K J 1/10W /0805		R139 R142
171182	RC-CHIP 180R J 1/10W /0805		R147 R163
179001	RC-CHIP OR /0805 2*1.25	MONO SOUND	R149
171150	RC-CHIP 150R J 1/10W /0805		R154
171102	RC-CHIP 100R J 1/10W /0805		R158 R105
171221	RC-CHIP 220R J 1/10W /0805		R164 R429
173273	CFR-CHIP 27K J 1/10W /0805		R165
171332	RC-CHIP 330R J 1/10W /0805		R170 R425
179001	RC-CHIP OR /0805 2*1.25		R176 R151
172333	RC-CHIP 3.3K J 1/8W /1206		R201 C336
170750	RC-CHIP 75R J 1/10W /0805		R209 R213
171334	RC-CHIP 330R J 1/8W /1206		R214 R215
172101	RC-CHIP 1K J 1/10W /0805		R216 R217
171104	CFR-CHIP 100R J 1/8W /1206		R220 R221
172335	RC-CHIP 3.3K J 1/10W /0805		R314 R310
173104	RC-CHIP 10K J 1/8W /1206		R317 R633
172123	RC-CHIP 1.2K J 1/8W /1206		R326 R330
171821	RC-CHIP 820R J 1/8W /1206		R328 R332
170473	CFR-CHIP 47R J 1/8W /1206		R329 R162
129150	RWF 1.5R J 1.5W	21",25",28",29",32"	R341
119104	RWF 1R J 1.5W (UFLB) 73MM	33"	R341
179002	RC-CHIP OR /1206		R342 R228
170332	RC-CHIP 33R J 1/10W /0805		R401 R412
170390	RC-CHIP 39R J 1/8W /1206		R404
170101	RC-CHIP 10R J 1/10W /0805		R421
172474	RC-CHIP 4.7K J 1/8W /1206		R434
172475	RC-CHIP 4.7K J 1/10W /0805		R435 R440
170472	RC-CHIP 47R J 1/10W /0805		R437 R438
171471	RC-CHIP 470R J 1/10W /0805		R439 R218
120234	RMF 22R J 1/2W	⚠	R503
110270	RMF 27R J .75W 52MM	⚠	R503
174180	RC-CHIP 180K J 1/10W /0805		R504
173333	RC-CHIP 33K J 1/10W /0805		R505 R102
173276	RC-CHIP 27K J 1/8W /1206		R506
114110	RM 100K %1 1/4W 26MM		R508
121182	RW 180R J 2W 73MM		R510
109472	CFR 0.47R J 1/2W /9 52MM	21", 25", 28" 4/3, 33"	R513
114151	RM 150K J 1/2W		R514 R517
119476	RMF 4.7R J 1W	21",25",28" 16/9, 29",32",33"	R516 R527
119271	RM 2.7R J 1/2W	25"	R518 R519
119271	RM 2.7R J 1/2W		R518 R519
119181	RMF 1.8R J 1W 52MM	28" 4/3	R518
119220	RM 2.2R J 1/2W	28"16/9	R519
119221	RM 2.2R J 1W	21"	R519
129395	RMF 3.9R J 0.5W 52MM	32"	R519
129395	RMF 3.9R J 0.5W 52MM		R519
119476	RMF 4.7R J 1W	⚠ 28"4/3	R519 R527

## PARTS LIST

PART NO	DESCRIPTION	NOTES	POSITION NUMBERS
111224	RMO 220R J 1W		R520
119480	RM 0.47R J 1/2W	21", 25"	R521 R606 R607
129471	RF 4.7R J 0.25W 52MM		R522
122114	RWF 1K J 1.5W 73MM		R523
113113	RMF 10K J 1/2W		R524
119152	RMO 1.5R J 2W	21"	R525
119184	RMO 1.8R K 3W R:20		R525
129475	RW 4.7R J 7W (YATIK)	29"	R525
129109	RWF 0.1R J 0.75W 73MM		R526
103116	CFR 10K J 1/4W /6 52MM		R528
119684	RMF 0.68R J 1W	⚠ 25"	R529
119122	RMF 1.2R J 1W	⚠ 28" 16/9	R529
119155	RMF 1.5R J 1W	⚠ 21", 32", 33"	R529
119110	RMF 1R J 1W	⚠ 28" 4/3	R529
129109	RWF 0.1R J 0.75W 73MM	⚠ 29"	R529
113335	RMO 33K J 1W		R531
154216	NTC 5.1R M (S234R)		R601
154225	PTC 18R/3 PIN	⚠ 28"16/9, 29",33"	R602
154234	PTC 9R/2 PIN - 3CYCLE	21"	R602
112393	RM 3.9K %1 1/4W 52MM		R605
119336	RM 0.33R %1 1W		R607
111101	RMO 1K J 1W		R608
113681	RMO 68K J 2W		R609
115470	RM 4.7M J 1/2W 52MM	⚠	R610
102105	CFR 1K J 1/2W /6 52MM		R611
119109	RNF 0.1R J 0.4W (UFLB) 52MM	⚠	R612
100473	CFR 47R J 1/4W /6 52MM		R617 R333
110476	RMO 47R J 3W		R618
113475	RMO 47K J 1W		R621 R629
173101	RC-CHIP 10K J 1/10W /0805		R622 R626
172273	RC-CHIP 2.7K J 1/10W /0805	⚠	R623
114115	RM 115K %1 1/4W	⚠ 21", 28" 16:9, 29", 32"	R625
114152	RM 150K F 1/4W 52MM	⚠ 25, 28" 4/3, 33"	R625
112131	RM 1.3K %1 1/4W 26MM		R627
111391	RM 390R %1 1/4W 26MM		R628
172105	RC-CHIP 1K J 1/8W /1206		R630 R236
111241	RM 240R %1 1/4W 26MM		R631 R632
100154	CFR 15R J 1/2W 52MM		R639
103273	CFR 27K J 1/4W /6 52MM	⚠	R645
103475	CFR 47K J 1/4W /6 52MM		R705
102159	CFR 1.5K J 1/2W /9 52MM	PS 29" HHOP U44	R711 R713 R715 R716
102166	CFR 1.5K J 1/4W /6 26MM	EXT.SPEAK.	R903
054261	FUSE 2.5AT (215 SER.)	⚠	S601
054280	FUSE 3.15AT (215)	⚠ PAL I 32"	S601
054263	FUSE T2A	⚠	S602
054264	FUSE T4A	⚠	S603
010760	SLIDE SWITCH 4P2P/4PST	32" 29"	S960
031251	SCART SOCKET 14.1		SK202 SK201
010861	ON/OFF SWITCH BK98	⚠ 25"	SW601
010712-03	POWER SWITCH S40 4/100A-250	⚠ 28",29",32"	SW601
010971	MAIN SWITCH GDE S40 4/100A-	⚠ 33"	SW601
010840-01	TACT SW LONG STEN 2LEG	33"	SW901 SW902
010840-01	TACT SW LONG STEN 2LEG	28"	SW901 SW902
010845	TACT SW WITH GREEN LED	32" 29"	SW901 SW902
010844	TACT SWITCH 2 LEG (MTSB)	25"	SW901 SW902
401141	TRN-CHIP BC848B SOT23	MONO SOUND	T101 T102
401141	TRN-CHIP BC848B SOT23		T103 T104 T105 T106
401142	TRN-CHIP BC858B SOT23		T301 T302 T303 T305 T308

## PARTS LIST

PART NO	DESCRIPTION	NOTES	POSITION NUMBERS
400989	TRN BC558B		T306 T309
401141	TRN-CHIP BC848B SOT23		T307 T403
401279	TRN 2SK2381		T501
401218	TRN BC618		T503
401215	TRN BU508DF		T504
401216-02	TRN 2SK2545		T601
401047	TRN BC337-25		
401142	TRN-CHIP BC858B SOT23		T980
401141	TRN-CHIP BC848B SOT23		T603 T604
410026	THRYSTOR MCR22-8		TH601
051709	DRIVER TRANSFORMER 11.1		TR501
057138-EL1	FBT 21" 14:2	⚠ 21" PF	TR502
057834-TR2	FBT 28" 16:9 14.1	⚠ 28" 16:9	TR502
058934-TR1	FBT 29" 14.1 (C-TYPE)	⚠ 29"	TR502
057534-EL2	FBT 2528 14.1	⚠ 25", 28"4/3	TR502
057334-EL1	FBT 33" 14.1	⚠ 33"	TR502
059138-EL1	SMPS 21" 14.2 P.FLAT	⚠ 21"	TR601
059834-TR1	SMPS 28" 16:9/SLOT TR/.....	⚠ 32"	TR601
059934-TR1	SMPS 29" 14.1	⚠ 29"	TR601
059534-TR1	SMPS 2528 14.1	⚠ 25", 28"	TR601
059834-TR1	SMPS 28" 16:9 14.1	⚠ 28" 16:9	TR601
059334-TR1	SMPS 33" 14.1	⚠ 33"	TR601
051805	COIL PFC 56MH DTH30563H ELI		TR602
7RZ136-PH3	TUNER PH ASIMETRIK UV1316/A		TU101
S99136-PH1	TUNER PH SPL ASIMETRIK UV1316 T	PIP	TU101
7RZ136-PH4	TUNER PH ASIMET. UV1316/ALG-3 SV22	PIP	TU201
031866	CONN.HOUSING X2006 GREY		X102
031035	PIN HEADETR 2.5MM 7.PC.MOLE	LL'	X104
031854	CONN.HOUSING X2003 GREY		X301 X405 X940
031858	CONN.HOUSING X2004 GREY		X302 X402
031780	CONN.HOUSING 2'LI GREY		X303 X501
031872	CONN.HOUSING X2007 BLACK		X403
031856	CONN.HOUSING X2003 BLACK		X404
031794	CONN.MALE HOR. 4.PIN PLUG		X502
031821	CON.HOUSING X2.5TMK 2204 GR		X503
031675	CON.HOUSING 2P MALE		X601 X602 X604 X605
031727	CON.MALE. 2.5TMK 2009S	PIP	X662
031882	CON.MALE X2.5TMK 2010G	PIP	X663
031530-01	INCHANG/CRT SOCKET ISHM05S-	⚠ Non Pure Flat	X703
031530-02	INCHANG/CRT SOCKET ISHM23S-	⚠ 21" Pure Flat	X703
031541	CRT SOCKET 29" DOUBLE FOCUS	⚠ Pure Flat	X703
031413	CONN.FEMALE 9 PIN		X801
31323	CON.MKF19400-6-0-1010		X802
031165	KONN. CINCH ..... YEL	SVHS	X921
031164	KONN. CINCH ..... RED	SVHS	X922
031163	KONN. CINCH ..... WHITE	SVHS	X923
031784	KONN.S-VHS B10B MONAKOR	SVHS	X924
031423	HEADPHONE JACK YKB21-5103		X941
031357	CON.HOUSING X2.5TMK 2904 G	EXT. SPEA.	X962
031021	PIN HEADETR 2.54MM 3.PC.MOL	29" 32"	X964
031020	PIN HEADETR 2.54MM 4.PC.MOL	29" 32"	X965
303826	DIODE Z. BZX55C 15V		ZD501
302782	DOIDE Z. MTZJ18B	21" Pure Flat	ZD501
303771	DIODE Z. UZT33V		ZD502
451885-01	IC TL431CLP (ON SEMICONDUCT		ZD602
303799	D- ZENER MTZJ12B		ZD603

## PARTS LIST

PART NO	DESCRIPTION	NOTES	POSITION NUMBERS
300193	DIODE Z. BZX55C9V1-GPS(VISH)		ZD606
S99170	PIP MODULE KPL.14.2	PIP	
056321-PH7	CPT PH A51ERF135*70 P.FLAT	⚠ 21" Pure Flat	
056325-VC4	CPT VC A59EHJ13X38	⚠ 25"	
056428-SB1	CPT SEB W66QDE893X286 (P.FLAT)	⚠ 28"16/9 Pure Flat	
056428-PS1	CPT PS W66EHK51X36	⚠ 28"16/9 Super Flat	
056328-VC6	CPT VC A66EHJ13X62	⚠ 28"4/3	
056329-SB1	CPT SEB A68QCP891X404	⚠ 29" Pure Flat	
056329-VC2	CPT VC A68EGD049X30 (S.FLAT	⚠ 29" Super Flat	
056432-PS2	CPT PS W76EKW10X21 P.FLAT	⚠ 32" Pure Flat	
056432-VC2	CPT VC W76EGV023X015 S FLAT	⚠ 32" Super Flat	
056333-VC3	CPT VC A80AEJ15X04	⚠ 33"	
525167-AS	DEGAUSSING COIL ASSY 25" BA	⚠ 25"	
628167-AS	DEGAUSSING COIL ASSY 28" BA	⚠ 28"4/3	
528166-AS	DEGAUSSING COIL ASSY	⚠ 28"16/9 Pure Flat	
621167-AS	DEGAUSSING COIL ASSY 21" BA	⚠ 21" Pure Flat	
528169-AS	DEGAUSSING COIL ASSY	⚠ 28"16/9 Super Flat	
629167-AS	DEGAUSSING COIL 29"	⚠ 29"	
532168-AS	DEGAUSSING COIL ASSY	⚠ 32" Pure Flat	
532169-AS	DEGAUSSING COIL ASSY	⚠ 32" Super Flat	
533167-AS	DEGAUSSING COIL 33"	⚠ 33"	
7P3187	RC A TYPE PRINTED SIL		
6VM187	RC A TYPE SILVER 14.1		
7UK187	RC A TYPE GREY 14.1		
7TK187	RC B TYPE FUME 14.1		
7PE187	RC B TYPE M.GREY 14.1		
5T1187	RC B TYPE SILV.14.1		
7UB109-AS	SPE.SUB 4R/20W(NOM)21T04/25	29"	
7UB107-AS	SPEAKER 8R/15W(MAX)21T04/25	29"	
6X1107-AS	SPK.8R/15W(MAX) 32"T20/T21	EXT.SPEAK.	
7UB108-AS	TWEETER 10R/10W(N)21T04/25T	29"	
7VA108-AS	TWEETER DYNAMIC D=52 8R/15W	33"	

Please note that Product Part List Files should be investigated for the mechanical parts like cabinets, etc.

